

sogeri

Lampes médicales et scientifiques

SOGERI distribue des lampes spéciales en France.

Dans ce catalogue, vous trouverez les lampes les plus importantes et les plus couramment utilisées dans votre profession. Si toutefois la lampe que vous recherchez n'y figure pas, n'hésitez pas à nous contacter, nous serons heureux de vous renseigner.

Notre collaboration avec de nombreux fabricants de lampes spéciales nous permet de :

- vous garantir une livraison rapide(*) pour de nombreux articles.
- vous fournir même les lampes les plus rares.

(*) délai moyen constaté : 24 à 48h.

Pour toute demande de devis : contact@sogeri.fr

Pour toute commande : Fax : 01.75.83.41.33

Pour tout retour de marchandises : Tél : 01.75.83.40.33

S.A.S. SOGERI au Capital de 10 000 Euros - 10, rue de Penthièvre 75008 PARIS
SIRET : 802 373 712 00016 / R.C.S. PARIS
T.V.A. : FR 91 802 373 712

SOMMAIRE

LAMPES POUR APPLICATIONS MEDICALES ET SCIENTIFIQUES

	pages
Guide de correspondance pour lampes de bloc opératoire	3
Guide de correspondance pour Photomètre	4
Guide de correspondance pour Endoscope	5
INDEX	6 - 7 - 8
Recherche par références OSRAM	9
Recherche par références PHILIPS	10
Lampes pour bloc opératoire : Berchtold, Martin, Dr.Mach (d' origine)	11
Lampes pour bloc opératoire : Berchtold, Martin, Dr.Mach (compatible))	12
Lampes pour bloc opératoire : Alm, Angénieux et supports	13 - 14
Lampes pour bloc opératoire HANAULUX (d' origine)	15
Lampes pour bloc opératoire HANAULUX (compatible)	16
Microscopie et projection : Lampes halogènes avec réflecteur	17 - 18
Microscopie et projection : Lampes halogènes sans réflecteur	19 - 20
Microscopie : lampes conventionnelles	
- avec collerette métallique	21 - 22
- sans collerette métallique	23 - 24 - 25
Microscopie : lampes à décharge	26
Lampes d'examen HEINE (d' origine)	27
Lampes d'examen HEINE (compatible)	28
Lampes d'examen WELCH ALLYN	29
Lampes d'examen	30 - 31
Lampes pour application dentaire	32 - 33
Lampes à rayons ultraviolets - Starters	34 - 35
Lampes pour Photo-Thérapie	36
Lampes à rayonnement infrarouge	37
Lampes pour visionneuse - négatoscope	38
Lampes pour instrumentation de laboratoire	39
Lampes pour instrumentation de laboratoire : Xénon - Vapeur de mercure	40
Lampes pour instrumentation de laboratoire : Xénon compactes	41
Endoscopie : lampes à décharge	42 - 43
lampes pour rétroprojecteurs	44
Douilles	45
Lampes miniatures	46 - 54

Guide de correspondance pour lampes de bloc opératoire

Hanaulux

Type	Code	Page
Amsterdam	HL-366	15 -16
Boston-London-V	HL-678	15 -16
Boston-London-V	HL-251	16
Boston-London-V	HL-253	15
Boston-London-V	HL-578	15
Boston-London-V	HL-685	15
Endo	HL-869	16
Frankfurt-London	HL-566	15 -16
Hamburg	HL-550	15 -16
Hamburg	HL-164	15 -16
Hamburg	HL-170	15
Hamburg	HL-579	16
Hamburg	HL-505	15
BLUELINE 30	HL-010	15 -16
BLUELINE 30IRC	HL-997	15
BLUELINE 80	HL-026	15 -16
BLUELINE 80IRC	HL-998	15
BLUELINE 100	HL-296	15 -16
BLUELINE 130/9	HL-198	15 -16
Hanaulux 1001	HL-852	16
Hanaulux 2000	HL-282	12 -15 - 16
Hanaulux3000	HL-947	15
Heidelberg	HL-769	15 -16
Hospitaleuchte	HL-191	15 -16
London-H	HL-566	15 -16
Melbourne-Oslo	HL-769	15 -16
Palma	HL-306	16
Palma	HL-306	16
Spezial	HL-488	15
Spezial	HL-653	15
Universal	HL-678	15 -16
Universal	HL-685	15

ALM - ANGENIEUX

Type	Code	Page
PRX 4000	JX-103	13
PRX 6000	JX-103	13
PRX 8000	JX-103	13
PRC 5000 / ECL	JX-120	13
PRC 7000 / ECL	JX-120	13
PRC 9000 / ECL	JX-120	13
AXCEL/ X-TEN/	HL-762	13
AX 4	JX-070	13
AX 4	JX-070CL	13
AX 4	JQ-129	12 - 20
AX 4 / AX14	JQ-249	12 -13-20-33
AX14	JX-100	13

Berchold

Type	Code	Page
B-480	TU-003	11
B-680	TU-003	11
B-950	TU-003	11
C-200	TU-001	11 - 12
C-300	TU-001	11 - 12
C-450	TU-002	11
C-450 alt	TU-003	11
C-452	TU-002	11
C-570	TU-004	11
C-571	TU-007	11
C-572	TU-007	11
C-950	TU-006	11
C-950G	TU-005	11
C-952	TU-005	11
D-200	TU-019	11
D-300	TU-020	11
D-300 (24 V)	TU-001	11 - 12
D-650	TU-005	11

Dr. Mach

Type	Code	Page
Mach 120	MA-040	11 - 12
Mach 130	MA-044	11
Mach 130F	MA-040	11 - 12
Mach 380F	MA-050	11
Mach 380DF	MA-050	11
Mach 400F	MA-050	11
Mach 400DF	MA-050	11
Mach 500F	MA-050	11
Mach 500DF	MA-050	11
Mach 700 F	MA-050	11
Mach 700 DF	MA-050	11
Quintaflex R96	MA-051	12
Praxila ab 1993	MA-040	11 - 12
Praxila bis 1993	MA-044	11
Soloflex	MA-064	12
Triaflex (R96) ab	MA-040	11 - 12
Triaflex (R96) bis	MA-044	11
Trigenflex R96	MA-050	11

Martin-Lampen

Type	Code	Page
86-903-00	MT-903	11
86-905-01	MT-905	11
86-907-01	MT-907	11
86-910-02	MT-910	11
86-970-00-04	MT-970	11
86-907-02-04	MT-907HX	11

**Guide de correspondance pour photomètres
et Spectrofluorimètre**

Fabricant	Type	Code	Page
Abbott	TDX/IMX	EFM	17 - 39
Bayer	Clinitek 200+	EKZ	17 - 39
	H2 Peroxkanal	FDT	17 - 20 - 39
Dade	Sysmex CA6000	KL-010	39
Eppendorf	Ecom 6122	JQ-010	19 - 39
	Spektr. Ip. Modell	SQ-043	39
Hitachi/Boehringer	704 / 705 / 717 / 737 / 747	ME-120	39
	911	ME-120	39
Hitachi	F1000/F2000	XL-0151	26 - 40
Hitachi/Merck	F1050/F1080	XL-0151	26 - 40
	F1000UV	XL-0154	40
	F1050/F1080 UV	XL-0154	40
	F1000/F2000 UV	XL-0154	40
	F4010	XL-0151	26 - 40
	F4010 UV	XL-0154	40
Helena	Electrophorese	DZA	19 - 39
	Electrophorese	NH-020	19
Kodak	Ektachem 381720	MR-1974	39
Krone	Analyzer	EH-620	19 - 39
Merck	Easy-SF	EH-620	19 - 39
	Magia 7000	KL-075	17 - 39
Mitsubishi	NK55131	ME-122	39
Molter-Ortho	Bilimeter	MI-063	39
Olympus	AU 500	JQ-122	33 - 39
Perkin Elmer	203/204	XL-0151	26 - 40
	MPF2A	XL-0151	26 - 40
	MPF3	XL-0151	26 - 40
	MPF4	XL-0151	26 - 40
	650	XL-0151	26 - 40
Sebiachem.	Electrophorese	EH-620	19 - 39
Shimatsu	RF535	XL-0151	26 - 40
	RF540	XL-0151	26 - 40
	RF551	XL-0151	26 - 40
	RF1501	XL-0151	26 - 40
	RF5000	XL-0151	26 - 40

Guide de correspondance pour Endoscope

Fabricant	Type	Code	Page	Fabricant	Type	Code	Page
3DScope	300W Xenon	CE-303	41 - 42	Origin Medical	300W Xenon	CE-303	41 - 42
Acufex	FRX300 Xenon	CE-303	41 - 42		175W	CE-303	41 - 42
	Acufex Xenon Ultra Lite	CE-303	41 - 42	Pentax	Processor OLX4 EM	CE-303	41 - 42
ALM MTA	Starpointe XE	CE-303	41 - 42		LX300	CE-303	41 - 42
ACMI/Circon	ALV-1, MV9098	CE-303	41 - 42		LX500A	CE-303	41 - 42
Baxter/Mueller	OPSIS VS5500	CE-303	41 - 42	Pilling	300W Xenon	CE-303	41 - 42
	OPSIS VS5600	CE-303	41 - 42	Snowden Pencer	Xenon L/S 300W	CE-303	41 - 42
Baxter/Edwards	OPTX300	CE-303	41 - 42	Storz	610	CE-303	41 - 42
BEI/Xylog	300W Xenon	CE-303	41 - 42		611	CE-303	41 - 42
Birtcher/Solos	ELS2	CE-175	41 - 42		615	CE-175	41 - 42
	GS9255	CE-303	41 - 42		300	CE-303	41 - 42
	GS9205	CE-303	41 - 42		630	CE-303	41 - 42
	SOLOS 3 CHIP/XENON INTEG	CE-303	41 - 42		487XE	CE-303	41 - 42
Cabot Medical	System 3000	CE-303	41 - 42		610C	CE-303	41 - 42
Circon/ACMI	ALV-1 and MV9098	CE-303	41 - 42		615XES	CE-303	41 - 42
Cooper Surgica	Endomed LSS700	CE-303	41 - 42		611C	CE-303	41 - 42
Dornier	Endognost	RP-502	43		LX175F	CE-303	41 - 42
Dyonics (Smith)	Dyo-Bright 3000 XE	CE-303	41 - 42		610XE	CE-303	41 - 42
Endo Image	300W Xenon	CE-303	41 - 42		615C	CE-303	41 - 42
Endolap	S605-25	CE-303	41 - 42		615XE	CE-303	41 - 42
	FO16000	CE-303	41 - 42		20133020 (300W)	CE-303	41 - 42
Endomedics	S1500	CE-303	41 - 42	Tgarno	35 AX ACUBEAM	CE-303	41 - 42
Endotech	XBO-R 100W/45	XL-0102	40 - 42	Vanguard	XR-350	CE-303	41 - 42
	XBO-R 100W/45-C	XL-0103	40 - 42		XR-35	CE-303	41 - 42
FPO(Fujinon)	EPX302 "Y1072" / Y1089"	CE-303	41 - 42		XR-300	CE-303	41 - 42
	FLXDS 300, 600	CE-303	41 - 42		XRM-4	CE-303	41 - 42
	EPX301A	CE-303	41 - 42	Video Dynamics	XLC-300	CE-303	41 - 42
	FLX300A	CE-303	41 - 42	Weck	WECKLITE300	CE-303	41 - 42
	FRX2000	CE-303	41 - 42	Wolf	300W Xenon	CE-303	41 - 42
	FLX300	CE-303	41 - 42		175W Model #5121	CE-303	41 - 42
Fuji	FLX2000	CE-303	41 - 42	Zeiss	Superlux300	CE-303	41 - 42
Linvatec	300W Xenon 8170	CE-303	41 - 42				
Luxtec	7000 (300W)	CE-303	41 - 42				
	9000/9300 (300W)	CE-303	41 - 42				
	1900 (150W) "Y1144"	CE-150	41 - 42				
	9175	CE-175	41 - 42				
	1300	CE-303	41 - 42				
	1600	CE-303	41 - 42				
Medical Dynami	6100XE	CE-303	41 - 42				
Mist	300W Xenon	CE-303	41 - 42				
Nextec	300W Xenon	CE-303	41 - 42				
	Nextec 300	CE-303	41 - 42				
Olympus	CLV 10	CE-303	41 - 42				
	CLV F10	CE-303	41 - 42				
	CLV U20	CE-303	41 - 42				
	ILX6300	CE-303	41 - 42				
	ILX/CLS/ILV/CLV-A (300W)	CE-303	41 - 42				
	XLS (175W) oder CLV-A (175W)	CE-175	41 - 42				
	CV-1	CE-303	41 - 42				
	CLV U40	CE-303	41 - 42				
	CLV S20	CE-303	41 - 42				

INDEX

code	page	code	page	code	page	code	page
12345	19	DZA	19 - 39	FLLA-58840	36 - 38	HL-282	12 - 15 - 16
55919	19	DZE-FDS	33	FLLA-58865	38	HL-296	15 - 16
55939	20	DYR	44	FLLA-58965	36 - 38	HL-306	16
AL-175	44	ECL1460	14	FLRI-22865	38	HL-339	15
AL-514	44	ECL1470	14	FLRI-32865	38	HL-344	12
AL-515	44	ECL1480	14	FLRI-40865	38	HL-366	15 - 16
AL-516	44	ED-600	25	FLT	17	HL-488	15
AX105054	14	EFM	17 - 39	FLUV-04005	35	HL-505	15
AX135457	14	EH-610	19	FLUV-06005	35	HL-550	15 - 16
AX162798	14	EH-620	19 - 39	FLUV-08009	34	HL-554	37
BAB	17 - 18	EH-622	19	FLUV-10009	34	HL-566	15 - 16
BLB-004	34	EJA	17	FLUV-14003	35	HL-578	15
BLB-006	34	EJL	17	FLUV-15005	35	HL-579	16
BLB-008	34	EJM	17	FLUV-15009	34	HL-653	15
BLB-009	34	EKE	18	FLUV-20003RS	35	HL-678	15 - 16
BLB-015	34	EKZ	17 - 39	FLUV-20005	35	HL-685	15
BLB-018	34	ELC	17	FLUV-20052	36	HL-762	13
BLB-036	34	ELD/EJN	18	FLUV-30005K	35	HL-769	15 - 16
BLB-125	34	EL-254	38 - 44	FLUV-40003RS	35	HL-852	16
BLB-160	34	ELH	17	FLUV-40005	35	HL-869	16
BLB-400	34	ENG	17	FLUV-40005K	35	HL-947	15
BVM	44	ENH	18	FNT	20	HL-997	15
CE-125	41	ENX	17	FSY	44	HL-998	15
CE-126	41	EPX/EPV	17	FTB	18	HMS-400	44
CE-150	41 - 42	EPZ	17 - 39	FTD	39	HMS-575	44
CE-151	41	EVW	18	FTE	18	HO-1105	27
CE-152	41	EXN	17 - 18 - 36	FTH	18	HO-1106	27
CE-175	41 - 42	EXR	18	FMW	18	HO-1107	27
CE-176	41	EXY	18	FRB	18	HO-1108	27
CE-178	41	FDT	17 - 20 - 39	GED	17	HO-1109	27
CE-303	41 - 42	FHS	18	HE-251	38 - 44	HO-1110	27
CE-300MODUL-	42	FHX	17	HF-001	33	HO-132	27 - 28
CE-303-MODUL-	42	FKUV-09071	36	HF-317	33	HO-134	27 - 28
CE-303STRYK	42	FKUV-18071	36	HF340	33	HO-135	27 - 28
CE-304	41 - 42	FKLA-18830	36	HF-341	33	HO-137	27 - 28
CE-305	41 - 42	FKLA-18950	36	HF-382	33	HO-138	27 - 28
CE-306	42	FKSA-11840	36	HK-137	28	HO-139	27 - 28
CE-307	41	FLCL-40	35	HK-141	28	HO-140	27
CE-310	42	FLCL-40R	35	HK-142	28	HO-141	27 - 28
CE-311	42	FLCL-80	35	HK-142	28	HO-142	27 - 28
CE-313	42	FLCL-80R	35	HK-156	28	HO-143	27
CE-314	42	FLCL-100	35	HK-157	28	HO-156	27 - 28
CE-500	41	FLCL-100R	35	HK-159	28	HO-157	27 - 28
CE-501	41	FLLA-04640	38	HL-001	37	HO-159	27 - 28
CE-502	41	FLLA-06640	38	HL-010	15 - 16	HO-169	27 - 28
CE-TM2Z	43	FLLA-08840	38	HL-026	15 - 16	HO-177	27 - 28
CE-TM12	43	FLLA-13640	38	HL-164	15 - 16	HO-184	27
CE-TMS	43	FLLA-15865	38	HL-150	37	HO-187	27
DDL	17 - 35	FLLA-18840	38	HL-170	15	HO-188	27
DDS	17	FLLA-18865	38	HL-191	15 - 16	HO-194	27
DED	17	FLLA-18965	36 - 38	HL-198	15 - 16	HO-198	27
DNF	17	FLLA-30865	38	HL-250	16	HO-2101	27
		FLLA-36840	38	HL-251	16	HO-2102	27
		FLLA-36865	38	HL-253	15		

INDEX

code	page	code	page	code	page	code	page
HO-244	27 - 28	JQ-241	20	KL-298	32	LW-411	25
HO-246	27 - 28	JQ-249	12 - 13-20-33	KL-528	32	LW-461	25
HO-247	27 - 28	JQ-250	20 44	KO-001	30	LW-471	25
HO-248	27	JQ-259	12 - 20 - 44	KO-001	30	LW-522	25
HO-249	27 - 28	JQ-291	12 - 16	KO-002	30	LW-612	25
HO-250	27	JQ-292	12 - 16	KO-003	30	LW-622	25
HO-251	27 - 28	JQ-436	20 - 44	KO-004	30	LW-822	25
HO-253	27	JQ-439	20	KO-005	30	MA-040	11 - 12
HO-262	27 - 28	JQ-440	20	KO-008	30	MA-044	11
HO-263	27	JQ-602	12	KO-012	30	MA-050	11
HO-270	27 - 28	JQ-668	20	KO-013	30	MA-051	12
HO-278	27	JQ-621	20	KO-018	30	MA-064	12
HO-286	27 - 28	JP-125	19	KO-020	30	MA-300	43
HO-289	27	JP-133	19	KO-021	30	ME-120	39
HO-290	27	JP-140	19	KO-041	30	ME-122	39
HO-291	27	JP-147	19	KO-042	31	MI-063	39
HO-4104	27	JP-168	19	KO-044	30	MI-064	23
HO-4111	27	JP-305	20	KO-045	30	MI-065	23
HO-460	27	JP-307	20	KO-046	30	MI-066	23
HO-468	27 - 28	JP-405	20	KO-047	30	MI-122	30
HO-481	27	JX-070	13	KO-065	31	MI-125	24
HO-493	27	JX-070CL	13	KO-066	30	MI-139	24
HO-894	31	JX-80	13	KO-068	30	MI-229	23
HPA400S	36	JX-100	13	KO-069	30	MI-251	24
HR-433	18	JX-103	13	KO-092	30	MI-274	24
HR-900	18	JX-120	13	KO-170	30	MI-275	24
HR-930	18	KE-1203	31	KO-171	30	MI-276	23
HTD-300	44	KE-1303	31	KO-172	30	MI-278	23
HTR-255	43	KE-1309	31	KO-367	31	MI-279	23
HTR-255M3	43	KE-1363	31	KO-618	31	MI-280	23
HTR-257	43	KE-1531	31	KO-676	31	MI-282	24
HTR-257DYO	43	KE-1558	31	KO-709	30	MI-283	23
HTR-400	43	KE-7034	31	KO-710	30	MI-284	23
HXP-120	26	KE-7042	31	LO-001	25	MI-285	23
JQ-010	19 - 39	KE-7156	31	LO-013	25	MI-286	23
JQ-012	19 - 33	KL-010	39	LO-014	25	MI-287	24
JQ-030	19 - 33	KL-013	32	LO-017	25	MI-288	23
JQ-032	19 - 33	KL-014	32	LO-018	25	MI-347	23
JQ-035	19	KL-016	32	LO-022	25	MI-3719	19
JQ-050	20	KL-017	32	LO-024	25	MI-389	24
JQ-052	33	KL-020	32	LO-029	25	MI-3900	30
JQ-059	20	KL-021	32	LO-032	25	MI-3910	30
JQ-095	20	KL-035	32	LO-100	25	MI-582	23
JQ-097	20	KL-075	17 - 39	LO-128	25	MI-582X	24
JQ-100	20 - 38	KL-100	17	LO-203	25	MI-643	20
JQ-109	20	KL-109	17	LW-225	25	MR-1974	39
JQ-122	33 - 39	KL-139	17	LW-241	25	MT-301	11
JQ-129	12 - 20	KL-150	17 - 32	LW-251	25	MR-240040007	30
JQ-150	20	KL-159	17	LW-272	25	MR-29012060	30
JQ-240	20 - 38	KL-165	32	LW-273	25	MT-707	11 - 12
						MT-903	11

INDEX

code	page	code	page	code	page	code	page
MT-905	11	OQ-750	22 - 30	SLX-004	14	WA-M21E001	29
MT-906	11	OQ-900	22 - 30	SLX-006	14	WM-10001D	34
MT-907	11	OQ-930	22 - 30	SLX-008	14	WM-100012	34
MT-907X	11	OS-111	33	SLAXL001	14	WM-15012	34
MT-908	11	OS-113	33	SLX10001	14	XL-0075	26 - 40
MT-910	11	OS-150	33	TH-150	37	XL-0076	40
MT-916	11 - 12	OS-151	33	TH-250	37	XL-0100	40
MT-950	11 - 12	OS-156	33	TU-001	11 - 12	XL-101	42
MT-970	11	OS-193	33	TU-002	11	XL-0102	40 - 42
MT-989	11	QL-0050	26 - 40	TU-003	11	XL-0103	40 - 42
NH-005	19	QL-0051	26	TU-004	11	XL-0151	26 - 40
NH-010	19	QL-0053	26 - 40	TU-005	11	XL-0151/13	40
NH-012	19	QL-0102	26 - 40	TU-006	11	XL-0152	40
NH-020	19	QL-0103	26 - 40	TU-007	11	XL-0153	40
NH-021	19	QL-0104	40 - 42	TU-008	11	XL-0154	40
NH-024	20	QL-0112	40	TU-014	11 - 12	XL-0180	40 - 42
NH-036	19	QL-0200	40	TU-018	11 - 12	XL-0181	42
NH-050	20	QL-0203	26 - 40	TU-019	11	XL-0185	40 - 42
NH-054	20	QL-0204	26	TU-020	11	XL-0254	40
NH-075	20	QL-0206	26	TU-021	12	XL-0300	26 - 42
NH-090	20	QL-0209	26 - 40	TUV6W-E	34	XL-0450	40
NH-120	12 - 20	QL-0233	26	UM-400	36	XL-0451	40
NH-124	20	RP-502P	43	UV-300	36	XL-0452	40
NH-150	20	RS-402	36	WA-025	29	XL-0453	26 - 40
NHF-012	19	SB-004	34	WA-026	29	XL-0454	40
NHW-005	19	SB-006	34	WA-028	29	13938	12
NHW-012	19	SB-008	34	WA-030	29	5761	19
NHW-020	19	SB-015	34	WA-031	29	55939	20
NHW-20-12	19	SB-025	34	WA-034	29	62138	38
NHW-024	20	SB-030	34	WA-037	29	8546XA	30
NHW-036	19	SB-036	34	WA-039	29	860	45
NHW-050	20	SB-055	34	WA-041	29	865R	45
OH-164	44	SB-075	34	WA-042	29	866R	45
OH-189	44	SB-115	34	WA-044	29	867R	45
OH-190	44	SB-683	34	WA-045	29	881	45
OQ-013	22	SBC-009	34	WA-047	29	884	45
OQ-053	21	SBC-011	34	WA-048	29	901	45
OQ-058	21	SBC-018	34	WA-049	29	905	45
OQ-063	21	SBC-036	34	WA-060	29	912	45
OQ-065	21	SI-150	37	WA-061	29	913	45
OQ-067	21	SI-176	37	WA-062	29	987	45
OQ-072	21	SI-250	37	WA-065	29	989	45
OQ-076	21	SI-251	37	WA-076	29	990	45
OQ-077	21	SI-252	37	WA-078	29	993	45
OQ-086	22	SI-375	37	WA-082	29	994	45
OQ-177	21	SQ-043	39	WA-083	29	64258	19
OQ-249	21	ST-111	35	WA-085	29	320XCITE	26
OQ-348	22	ST-192	35	WA-095	29 - 42		
OQ-464	22	S2	35	WM-08012	34		
OQ-505	21	S25	35				
OQ-615	21						

Recherche par références OSRAM

Osram	SOGERI	page	Osram	SOGERI	page
41900SP	HR-900	18	64617	KL-017	32
41930SP	HR-930	18	64618	DED	17
54745	ELD/EJN	18	64619	EPX/EPV	17
62138	62138	38	64620	KL159/05	17
64111	OS-111	33	64621	JQ-621	20
64150	OS-150	33	64623	JQ-109	20
64151	OS-151	33	64624	KL-035	32
64156	OS-156	33	64625	JQ-100	20 - 38
64193	OS-193	33	64626	JQ-122	33 - 39
64222	JQ-012	19 - 33	64627	KL-100	17
64223	JQ-010	19 - 39	64628	FDT	17 - 20 - 39
64225	EH-610	19	64633	JQ-150	20
64250	EH-620	19 - 39	64634	KL-150	17 - 32
64251	EH-622	19	64637	KL-109	17
64255	KL-020	32	64638	JQ-129	12 - 20
64260	JQ-032	19 - 33	64640	JQ-240	20 - 38
64261	JQ-030	19 - 33	64641	JQ-241	20
64275	JQ-035	19	64642	JQ-249	12 - 13 - 20 - 33
64291XIR	JQ-291	12 - 16	64643	DZE-FDS	33
64317	HF-317	33	64647	NH-120	12 - 20
64340	HF-340	33	64650	HL-282	12 - 15 - 16
64341	HF-341	33	64653	ELC	17
64342	HF-001	33	64655	JQ-250	20 44
64382	HF-382	33	64656	FNT	20
64405	NHW-005	19	64657	JQ-259	12 - 20 - 44
64405S	NH-005	19	64658	GED	17
64410S	NH-010	19	64663	JQ-436	20 - 44
64415	NHW-012	19	64664	JQ-439	20
64415S	NH-012	19	64665	JQ-440	20
64425	NHW-020	19	64668	JQ-668	20
64425S	NH-020	19	64680	OH-189	44
64427S	NH-021	19	64686	DYR	44
64432	NHW-036	19	64730	OH-164	44
64432S	NH-036	19	93506	ENH	18
64435U	NH-024	20	93510	EXY	18
64440	NHW-050	20	93515	EXR	18
64440S	NH-050	20	93518	ELH	17
64445U	NH-054	20	93525	ENX	17
64450S	NH-075	20	93591	FSY	44
64458S	NH-090	20	93631	DNF	17
64460U	NH-124	20	93638	EKE	18
64465U	NH-150	20	5001	ED-600	25
64514	AL-514	44	8001	LO-001	25
64516	AL-516	44	8013	LO-013	25
64540	BVM	44	8014	LO-014	25
64575	AL-175	44	8017	LO-017	25
64602	JQ-602	44	8018	LO-018	25
64607	EFM	17 - 39	8022	LO-022	25
64609	JQ-052	33	8024	LO-024	25
64610	JQ-050	20	8029	LO-029	25
64611	JQ-059	20	8032	LO-032	25
64613	KL-013	32	8100	LO-100	25
64615	KL-075	17 - 39	8128	LO-128	25
			8203	LO-203	25

Recherche par références PHILIPS

Philips	SOGERI	page
5761	5761/04	19
5968	OH-190/04	44
5972	JQ-010	19 - 39
5973	FDT	17 - 20 - 39
5974	DZE-FDS	33
6423	KL-150	17 - 32
6423/5H	KL-159	17
6550	JQ-150	20
6680	JQ-249	12 -13-20-33
6834	KL-100	17
6839C	JQ-122	33 -39
6847	EFM	17 - 39
6853	KL-075	17 - 39
6899	TU-001	11 - 12
6958	JQ-259	12 - 20 - 44
7023	JQ-100	20 - 38
7027	JQ-050	20
7158 XHP	JQ-240	20 - 38
7387	EH-610	19
7388	EH-620	19 - 39
7389	OH-189	44
7724	JQ-109	20
7748 XHP	JQ-250	20 44
7764	OH-164	44
7787 XHP	JQ-436	20 - 44
12345	12345/04	19
13089	NH-124	20
13090	NH-054	20
13091	NH-024	20
13095	ENH	18
13096	ELH	17
13102	NH-050	20
13131	GED	17
13137	FHX	17
13139	KL-139	17
13158	ELD/EJN	18
13160	DDS	17
13163	ELC	17
13164	EJL	17
13165	KL-165	32
13186	EPX/EPV	17
13189	EPZ	17 - 39
13194	DED	17
13298	KL-298	32
13390	KL-020	32

Philips	SOGERI	page
13528	KL-528	32
13629	EKE	18
13632	EXY	18
13634	FHS	18
13701	NH-120	12 - 20
13711	FLT	17
13824	ENX	17
13830	EVW	18
13865	KL-017	32
13938	13938	12
14501	DDL	17 - 35
14502	EXR	18
14529	DNF	17
14623	JQ-097	20
14623P	JQ-095	20
TL20/52	FLUV-20052	36

Lampes pour bloc opératoire :Berchtold,Martin,Dr.Mach

LAMPE D' ORIGINE

Code	Réf. Berchtold	Tension [Volt]	Puissance [Watt]	culot	Dimensions [mm]	Figure
TU-019/90	CZ 940-12	12	35	G6,35	14x55	301
TU-020/90	CZ 955-12	12	50	G6,35	14x55	301
TU-002/90	CZ 905-22	22,8	110	G6,35	14x50	366
TU-004/90	CZ 906-24	22,8	150	G6,35	14x50	301
TU-005/90	CZ 907-22	22,8	250	G6,35	14x55	301
TU-001/90	CZ 904-24	22,8	55	G6,35	14x55	301
TU-008/90	CZ 908-22	22,8	150	G6,35		366
TU-018/90	CZ 916-04 dépolie	24	25	Ba20d	40x70	363
TU-003/90	CZ 905-24	24	100	G6,35	13x50	301
TU-007/90	CZ 908-24	24	150	G6,35	13x55	301
TU-006/90	CZ 907-24	24	250	G6,35	14x50	301
TU-014/90	CZ 914-04	24	50/50	Ba22d	80x126	361
Réf. Martin						
MT-301/107**	86-903-01-04 ML-301	12	50	GU5,3	50X32	303
MT-707/107	98-004-707	15	150	Cable		360
MT-903/107	86-903-00	22,8	50	G6,35	10x42	366
MT-905/107*	86-905-01 ML-501	24	120	G6,35	14x50	366
MT-906/107	86-950-13-04	24	100			
MT-907/107*	86-907-01 ML-701	24	150	G6,35	14x50	301
MT-907HX/107	86-907-02-04 ML-702X					n.c
MT-910/107*	86-910-00 ML-1001	24	250	G6,35	14x50	301
MT-970/107	86-970-00 ML-702	24	50	Ba20d		n.c
MT-908/107	86-908-02-04 ML-502X	90	70	G12		n.c
MT-989/107	89-907-02-04		70 + 150	G12 + G6,35		n.c
Réf. Dr. Mach						
MA-050/101	1660/91	22,8	50	G6,35	10x37	366
MA-040/101	1240/91	22,8/24	40/50	G6,35	10x41	366
MA-044/101	1210/91H	22,8/24	40/50	Ba15d	10x52	n.c

* boîte de 6 lampes + douilles

** lampe + douille

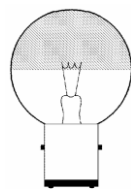

361

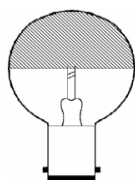

363



421



301



366



360

Lampes pour bloc opératoire : Berchtold, Martin, Dr. Mach

LAMPE COMPATIBLE

Code	Réf. Berchtold/Osram	tension [Volt]	Puissance [Watt]	culot	Dimensions [mm]	Figure
JQ-602	CZ 955-12/64602	12	50	G6,35	14x55	301
NH-120	CZ 905-22/64647	24	120	G6,35	14x50	366
JQ-291	64291XIR	22,8	40	G6,35	12X44	367
JQ-249	CZ 906-24/64642	22,8	150	G6,35	14x50	301
JQ-259	CZ 907-22/64657	22,8	250	G6,35	14x55	301
TU-001/04	CZ 904-24/6899 Philips	22,8	55	G6,35	14x55	301
JQ-249	CZ 908-22/64642	22,8	150	G6,35	12,44	301
JQ-292	64292XIR	22,8	150	G6,35	12,44	367
TU-018/70	CZ 916-04 dépolie	24	25	Ba20d	40x70	363
JQ-129	CZ 905-24/64638	24	100	G6,35	13x50	301
TU-021/88	CZ 905-00	24	120	G6,35	11x44	301
JQ-249	CZ 908-24/64642	24	150	G6,35	13x55	301
JQ-259	CZ 907-24/64657	24	250	G6,35	14x50	301
TU-014/40	CZ 914-04	24	50/50	Ba22d	80x126	361
Réf. Martin/Osram						
MT-707/100	98-004-707	15	150	Cable		360
HL-282/05	86-903-00/64650	22,8	50	G6,35	10x42	366
MT-950/88	86-950-00	24	25	Ba20d	40x70	n.c
NH-120	86-905-01 /64647	24	120	G6,35	14x50	366
JQ-249	86-907-01 /64642	24	150	G6,35	14x50	301
JQ-259	86-910-00 /64657	24	250	G6,35	14x50	301
MT-916/100	88-916-02	24	50	Ba20d	40X70	363
Réf. Dr. Mach						
HL-282/05	1660/91	22,8	50	G6,35	10x37	366
MA-040/100	1240/91	22,8/24	40/50	G6,35	10x41	366
MA-051/05	1663/3 dépolie	24	50	G6,35	10X42	366
MA-064/18	1150/91	24	60	Ba20d	39x67	363
HL-344/88	Apollon	24	35	Ba15d	50x76	363
13938	Admecco	22,8	50	GX5,3	50x45	303

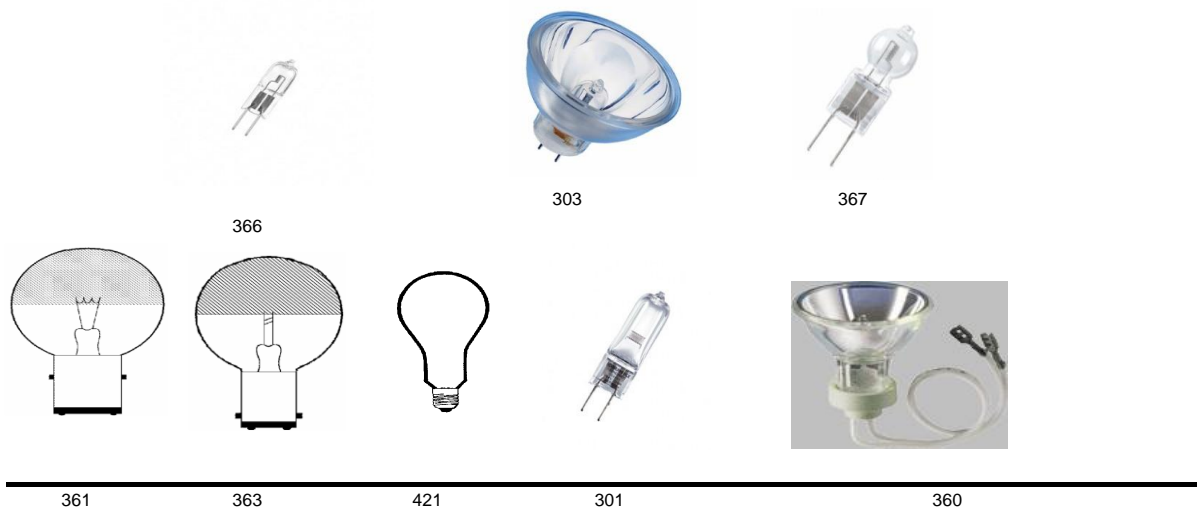

Lampes pour bloc opératoire : Alm, Angénieux, BBT

Originale ou Compatible (à préciser)

Code	Réf. Alm/Angénieux	Tension	Puissance	culot	Figure
JX-070CL	AX 153092 claire	24	70	X511	1
JX-070	AX 104316 sablée	24	70	X511	1
JX-80	BBT	24	80	X511	1
JX-100	AX 153091	24	100	X511	1
JX-103	PRX 4000/6000/8000	23	100	X514SP	3
JX-103CLIPS	LOT DE 20 CLIPS POUR SUPPORT LAMPES PRX 4000/6000/8000				
JX-120	PRC 9000/7000/5000	24	120	X514	2
HL-762	AX 186762 XTEN/AXCEL	24	100	GX6,35	301
JQ-249	AX 163508	24	100	G6,35	301
JQ-259DEP	AX 76554	24	250	G6,35	301



1



2



3



301

Support de lampes

Réf. Fabricant	Réf. Appareil	Réf. Appareil	Figure
ARD567903006	HLX3000	1X40W	21
ARD369007997	BLUELINE 30 IRC	Support lampe	22
ARD369006997	BLUELINE 80 IRC	Support lampe principal	23
ARD 369005997	BLUELINE 80 IRC	Support lampe de réserve	24
ARD368112998	G8 e	Support lampe V2	25
HM56050727	HLX 2000	Support lampe	26
HM56053063	BLUELINE 30	Support lampe	27
HM56053073	BLUELINE 80	2 supports de lampe	27
HM56053256	BLUELINE 80	Support lampes double	28
HM56053206	BLUELINE 90	Support lampe	29
HM56053216	BLUELINE 130	Support lampe	30



21



22



23



24



25



26



27



28



29



30

Support de lampes

	Réf. Fabricant	Réf. Appareil	Réf. Appareil	Figure
SLX -004	SLX 004	ARD 367202489	PRX 4000	10
SLX- 006	SLX 006	ARD 367202488	PRX 6000	11
SLX- 008	SLX 008	ARD 367202487	PRX 8000	12
ECL 1460	ECL 1460	ARD 567077999	PRC 5000	13
ECL 1470	ECL 1470	ARD567078999	PRC 7000	14
ECL 1480	ECL 1480	ARD 567079999	PRC 9000	15
AX 105054	ARD 105054		AX4	18
AX 135457	ARD 135457		AX8	19
AX 162798	AX 162798		AX4/AX10/AX14	20
SL AXL 001	SL AXL 001	ARD 367501950	AXCEL	16
SL X10001	SL X10001	ARD 367819998	X TEN	17

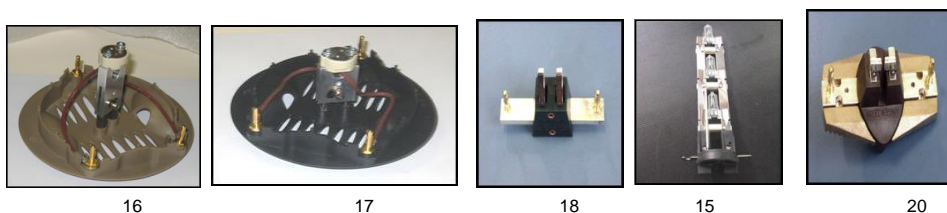
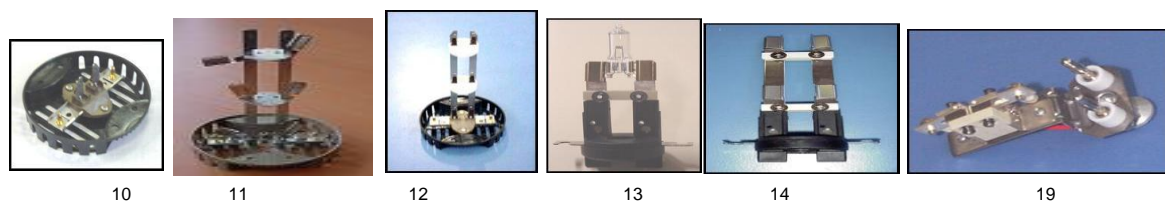

Lampes pour bloc opératoire HANAULUX

LAMPE D'ORIGINE

Code	Réf. Hanaulux	Tension [Volt]	Puissance [Watt]	culot	Dimensions [mm]	Figure
HL-191/25	56016191	12	25	Ba15d	40x63	363
HL-653S/25	56004653	12	100	Cable	50x32	360
HL-026/25	56053026 blue 80	21,5	130	spécial		432
HL-998/25	369002997 Blue 80 IRC	22,8	80	GY6,35		367
HL-198/25	56053198 blue 90/130	22,8	90	spécial		433
HL-769/25	56018769	22,8	40	G6,35	10x42	301
HL-947/25	567901940 HLX 3000	22,8	40	G6,35	12X44	367
HL-282/25**	56115282 HLX 2000	22,8	50	G6,35	10x42	366
HL-566/25	56018566	22,8	50	G6,35	10x42	301
HL-366/25	56018366	22,8	75	R7s	13x64	304
HL-296/25	56053296 blue 100	22,8	113	G6,35		434
HL-164/25	56016164	24	25	Ba15d	40x63	363
HL-339/25	56053339 décharge +	24	100			306
HL-550/25	56018550	24	40	Ba15d	40x63	363
HL-010/25	56053010 blue 30	24	50	spécial		431
HL-997/25	369001997 Blue 30 IRC	22,8	40	GY6,35		367
HL-678/25	56016678	24	50	Bx22d	50x80	361
HL-505/25	56018505	50	30	Ba15d	40x63	363
HL-685/25	56016685	50	50	Bx22d	50x80	361
HL-253/25	56018253	240/250	50	Bx22d		n.c

** hanauchrome HLX2000 boîte de 8 lampes + outil

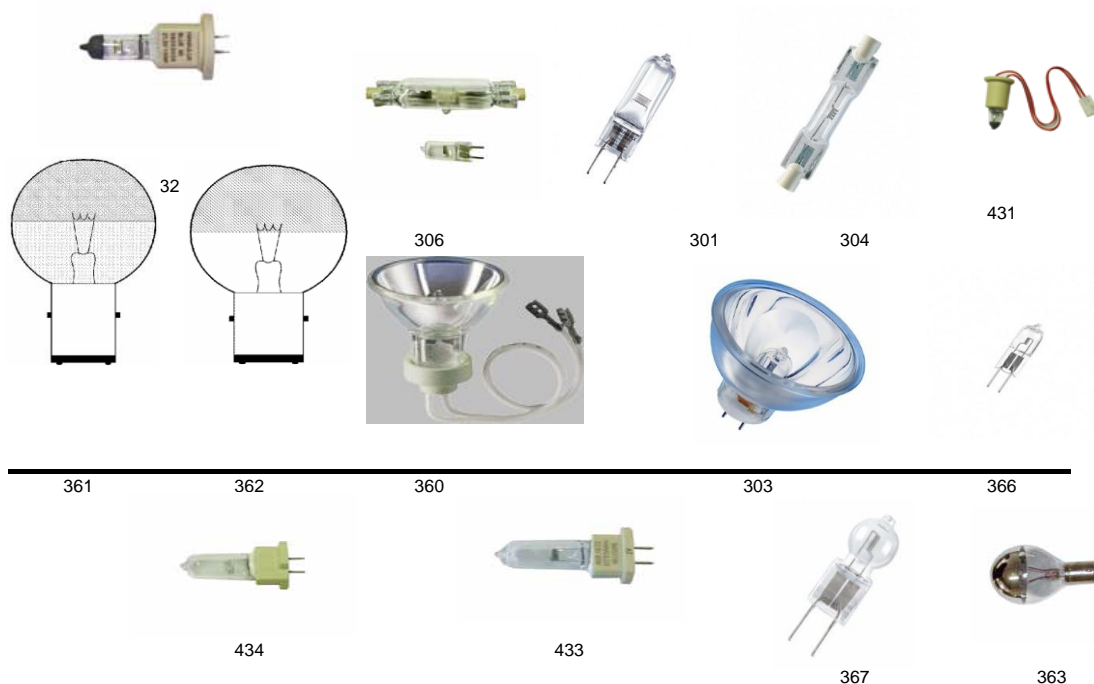

Lampes pour bloc opératoire HANAULUX

LAMPE COMPATIBLE

Code	Réf. Hanaulux	Tension [Volt]	Puissance [Watt]	culot	Dimensions [mm]	Figure
HL-191	56016191	12	25	Ba15d	40x63	363
HL-852	56051852	12	50	GU6,35	50x32	303
HL-869	56018869	15	150	GZ6,35	50x32	303
HL-026	56053026 blue 80	21,5	130	spécial		432
HL-198	56053198 blue 90/130	22,8	90	spécial		433
HL-769	56018769	22,8	40	G6,35	10x42	301
JQ-291	64291 XIR	22,8	40	G6,35	12X44	367
HL-282	56115282	22,8	50	G6,35	10x42	366
HL-566	56018566	22,8	50	G6,35	10x42	301
HL-366	56018366	22,8	75	R7s	13x64	304
HL-296	56053296 blue 100	22,8	113	G6,35		434
JQ-292	64292 XIR	22,8	150	G6,35	12X44	367
HL-164	56016164	24	25	Ba15d	40x63	363
HL-306	56018306	24	40	Bx22d		362
HL-550	56018550	24	40	Ba15d	40x63	363
HL-010	56053010 blue 30	24	50	spécial		431
HL-678	56016678	24	50	Bx22d	50x80	361
HL-579	56016579	32	40	Ba15d	40x63	363
HL-250	56018250	220	50	Bx22d	50x80	362
HL-251	56018251	220	50	Bx22d	50x80	361

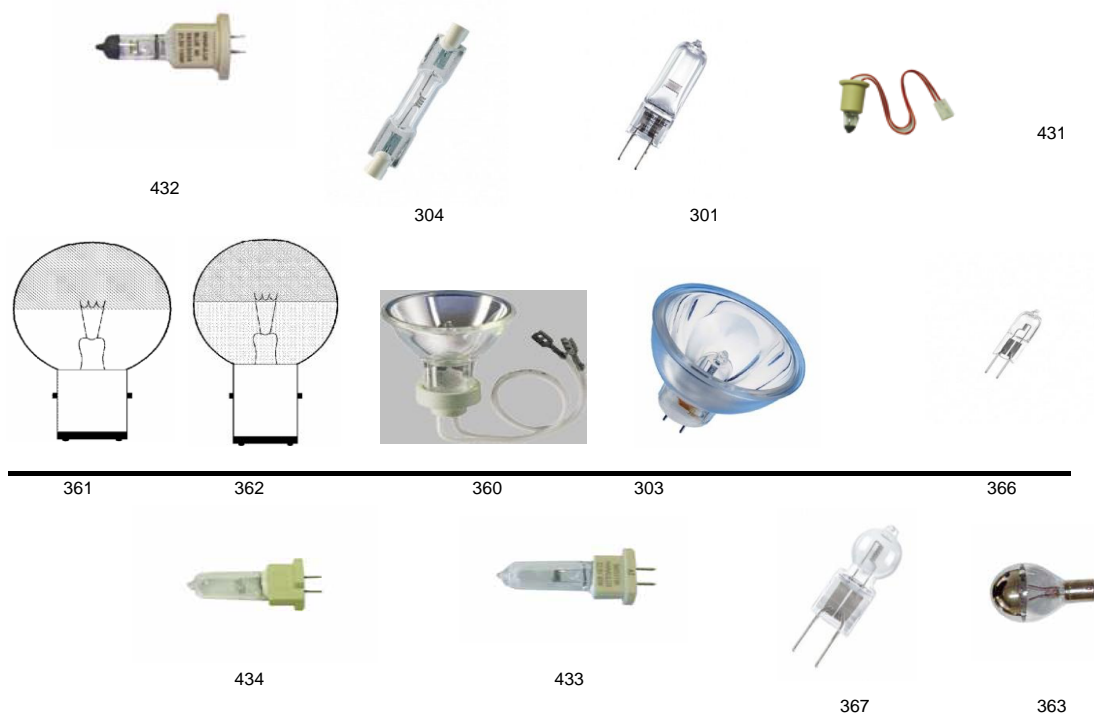

Lampes halogènes avec réflecteur

Microscopie et projection

	Références	Tension	Puissance	Culot	Durée de vie	Figure
	Osram / Philips	[Volt]	[Watt]		[hrs]	
EFM	64607	8	50	GZ6,35	50	303
EKZ		10,8	30	GX5,3	200	303
BAB-SL	44860WFL	12	20	GU5,3	4000	303
FTD	44890WFL/12302	12	20	GU4	3500	306
ENL	GE25475	12	50	GX5,3	2000	303
EXN-SL	44870WFL/6461	12	50	GX5,3	4000	303
KL-075	64615HLX/6853 EFN	12	75	GZ6,35	50	303
KL-139	TYPE 13139	12	75	GZ6,35	25	303
KL-100	64627HLX/6834 EFP	12	100	GZ6,35	50	303
KL-109	64637 / EBV	12	100	GZ6,35	1500	303
FLT	GE 25261	13,8	25	GZ4	500	341
FHX	PH13137	13,8	25	GX5,3	250	303
EPZ	PH13189	13,8	50	GX5,3	1000	303
DED	64618 / 13194	13,8	85	GX5,3	1000	303
GED	64658 / 13131	13,8	85	Kabel	1000	360
EPX/EPV	64619 / 3186	14,5	90	GX5,3	500	303
KL-150	64634HLX / 6423 EFR	15	150	GZ6,35	50	303
KL-159	64620 / 6423/5H	15	150	GZ6,35	500	303
DDL	PH14501	20	150	GX5,3	500	303
DDS	PH13160	21	80	GX5,3	1000	306
DNF	93631 / 14529	21	150	GX7,9	25	307
EJA		21	150	GX5,3	40	303
EJM		21	150	Gx5,3	40	303
ELC	64653HLX 13163	24	250	GX5,3	50	303
EJL	PH13164	24	200	GX5,3	50	303
ENX	93525 / 13824	82	360	GY5,3	75	303
ELH	93518 / 13096	120	300	GY5,3	35	303
ENG		120	300	GY5,3	15	303



50x50mm

360

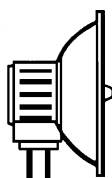

50x45mm

307



50x45mm

303



35x45mm

306



35x40mm

341

Lampes halogènes avec réflecteur

Microscopie et projection

Code	Références Osram /Philips	Tension [Volt]	Puissance [Watt]	Culot	Durée de vie [hrs]	Figure
FTB-CG	44890SP 10°	12	20	GU4	2000	341
FTE-TIT	46892SP 10°	12	20	GU4	2000	341
FTH-BR	26063 30°	12	35	GU4	2000	341
HR-433	6433 6°	12	20	Ba15d	2000	299
BAB-IRC	48860WFL 36°	12	20	GU5,3	4000	306
FRB-IRC	48865SP 10°	12	35	GU5,3	4000	306
FMW-TIT	46865WFL 36°	12	35	GU5,3	4000	306
FMW-IRC	48865FL 36°	12	35	GU5,3	4000	306
EXN-IRC	48870WFL 38°	12	50	GU5,3	4000	306
EXZ-IRC	48870FL 24°	12	50	GU5,3	4000	306
FNV-IRC	48870VWFL 60°	12	50	GU5,3	4000	306
FNV-TIT	46870VWFL 60°	12	50	GU5,3	4000	306
HR-900	41900SP	12	20	GY4	2000	300
EKE	93638 / 13629	21	150	GX5,3	200	306
ELD/EJN	PH13158	21	150	GX5,3	40	306
HR-930	41930SP	24	20	GY4	1000	300
EVW	PH13830	82	250	GY6,35	50	306
EXY	93510 / 13632	82	250	GX5,3	250	306
EXR	93515 / 14502	82	300	GX5,3	35	306
FHS	PH13634	82	300	GX5,3	70	306
ENH	93506 / 13095	120	250	GY5,3	175	306



35x40mm

341



45x51mm

306



48x38

300



37x42mm

299

Lampes halogènes sans réflecteur
Microscopie, projection, microfiche

Code	Références	[Volt]	[Watt]	Culot	Durée de vie [hrs]	Figure
EH-610	Osram 64225 7387 ESA	6	10	G4	100	308
JP-125	NARVA 55125	6	10	PY16-1,25	100	349
JQ-010	64223 / 5972	6	10	G4	300	308
JQ-012	64222	6	10	PG22	300	309
NH-010*	64410S	6	10	G4	4000	366
EH-620	64250HLX 7388 ESB	6	20	G4	100	308
EH-622	64251HLX	6	20	PG22	100	309
JP-133	NARVA 55133	6	20	PY16-1,25	100	349
JP-147	NARVA 55147	6	25	PY16-1,25	100	349
5761	5761	6	30	G4	100	308
JQ-035	64275	6	35	G4	50	366
JP-168	NARVA 55168 HLW55A	6	30	PY16-1,5	100	349
DZA		10,8	30	G5,3	400	377
NHW-005	64405	12	5	G4	2000	308
NH-005*	64405s	12	5	G4	4000	366
NHW-012	64415	12	10	G4	2000	308
NH-012*	64415S	12	10	G4	2000	366
NHF-012	64418 300°C	12	10	G4	2000	308
JP-140	NARVA 55140	12	20	PY16-1,25	1000	349
NH-020*	64425S / 13078A-UB	12	20	G4	4000	366
NHW-020	64425	12	20	G4	2000	308
NHW-020-12	NARVA 55917	12	20	G4	2000	308
55919/67	NARVA 55919	12	20	G4	1000	308
12345	12345	12	20	G4	400	308
64258	64258 HLX	12	20	G4	2000	308
NH-021*	64427S	12	20	GY6,35	4000	366
JQ-030	64261	12	30	G6,35	50	301
JQ-Q-032	64260	12	30	PG22	50	309
MI-3719	WILD HLX3719	12	30	SPECIAL		404
NH-036*	64432S	12	35	GY6,35	4000	366
NHW-036	64432	12	35	GY6,35	2000	308

*filament vertical



308



349



309



377



301



366

Lampes halogènes sans réflecteur
Microscopie, projection, microfiche

Code	Références Osram / Philips	Tension [Volt]	Puis. [Watt]	Culot	Durée de vie [hrs]	Figure
JQ-050	64610HLX / 7027 BRL	12	50	G6,35	50	305
MI-643	LEICA 384-643	12	50	Special		404
JQ-059	64611HLX	12	50	G6,35	100	305
NH-050*	64440S / 13102A	12	50	GY6,35	4000	301
NHW-050	64440	12	50	GY6,35	2000	305
NH-075*	64450S	12	75	GY6,35	4000	301
NH-090*	64458S	12	90	GY6,35	4000	301
FDT	64628 / 5973 / 35321	12	100	GY9,5	50	374
JP-305	NARVA 55305	12	100	PY24-1,5	50	348
JQ-100	64625HLX / 7023 FCR	12	100	GY6,35	50	305
55939/67	NARVA 55939	12	100	G6,35-15		
JP-307	NARVA 55307	12	100	PY24-1,5		
JQ-109	64623HLX / 7727 EVA	12	100	GY6,35	2000	305
JQ-621	64621HLX	12	100	PG22	2000	309
JQ-150	64633HLX / 6550 BRJ	15	150	G6,35	50	301
JQ-095	14623P	17	95	GZ9,5	350	374
JQ-097	14623	17	95	G6,35	350	305
JQ-668/05	64668 XIR	22,8	80	G6,35		
NH-024*	64435U / 13091	24	20	G4	2000	308
NH-054*	64445U / 13090	24	50	GY6,35	2000	301
JQ-129	64638HLX	24	100	G6,35	300	301
NH-124*	64460U / 13089	24	100	GY6,35	2000	301
NH-120*	64647 / 13701	24	120	G6,35	300	301
NH-150*	64465U	24	150	GY6,35	2000	301
JP-405	NARVA 55405	24	150	PY24-1,5	50	348
JQ-240	64640HL/7158XHP FCS	24	150	G6,35	50	301
JQ-241	64641HLX	24	150	G6,35	2000	301
JQ-249	64642HLX/6680 FDV	24	150	G6,35	300	301
JQ-250	64655HLX/7748XHP EHJ	24	250	G6,35	50	301
JQ-259	64657HLX/6958 EVC	24	250	G6,35	300	301
FNT	64656	24	275	G6,35	75	301
JQ-436	64663HLX/7787XHP EVC	36	400	G6,35	50	301
JQ-440	64665HLX/7787LL	36	400	G6,35	300	301
JQ-439	64664HLX	36	400	G6,35	150	301

* filament vertical

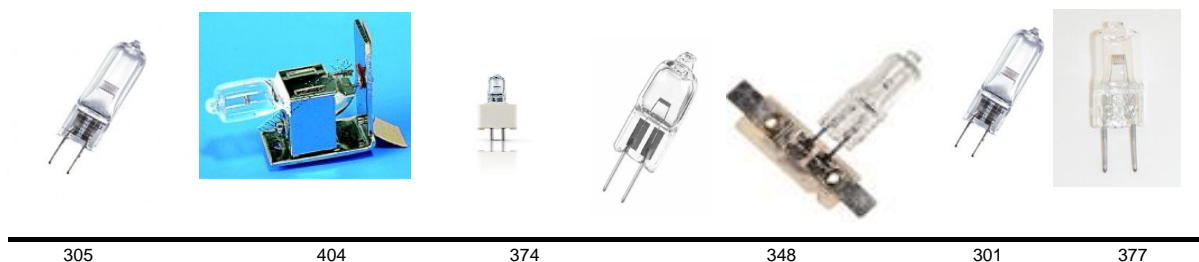

305

404

374

348

301

377

**Microscopie : lampes conventionnelles
avec collerette métallique**

Code	Références	Tension [Volt]	Puiss. [Watt/A]	Culot	Dim. Lampe	Figure
OQ-072	390172 ZEISS	6	5	Px16s	15x27	400
OQ-067	35334 LS15 Olympus	6	15	Spéc. Bakélite	22x74	310
OQ-076	380176-1730 ZEISS	6	15	Px22d	17x53	1/332
OQ-077	380018-1740 ZEISS	6	15	P25D/4	18x51	333
OQ-177	500-177 Leitz	6	15	P25D	17x53	334
OQ-505	70505 Rodenstock	6	15	S15d/20	19x53	468
OQ-615	Nikon TNK	6	15	P25d/4	20x53	4/332
OQ-249	70249 WILD	6	20	P21d/collerette	18x52	335
OQ-053	390153 ZEISS	6	25	P47d	25x65	318
OQ-058	390158 ZEISS	6	30	P47d	35x63	316
OQ-063	390163 ZEISS	6	30	Cable	35x85	405
OQ-065	35335 LS 30 Olympus	6	30	Spéc. Bakélite	25x78	310



4

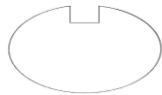

1

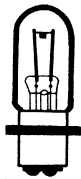

332



333



334



400



318



468



316



405



310



335

**Microscopie : lampes conventionnelles
 avec collerette métallique**

Code	Références	Tension [Volt]	Puiss. [Watt/A]	Culot	Dim.	culot/Fig.
OQ-086	zeiss 390186	6	50	P47d		316
OQ-750	Haag streit HS940-950	6	4,5A	P40s	34x63	402
OQ-930	Haag streit HS900-930	6	4,5A	P44s	35x65	403
OQ-464	Rodenstock 70464	12	25	SX15s/22		318
OQ-900	Haag streit BC900	12	30	Spécial		319
OQ-013	390213	12	35	P47d	35x63	317
OQ-348	380018-2520	12	60	Ba20d	35x69	315



317



403



402



318



316



315



319

**Microscopie : lampes conventionnelles
sans collerette métallique**

Code	Références	Caractéristiques	Tension [Volt]	Puissance [Watt]	Culot	Durée /Figure de vie
MI-066	Olympus 35321	claire	3	2A	Ba15s	399
MI-064	Olympus 35325		6	10	E10	
MI-283	OP2801	claire	6	10	Ba15d	100 / 324
MI-286	OP2128	claire	6	15	Ba15d	100 / 324
MI-347	13347W	claire	6	15	Ba15d	100 / 389
MI-065	Olympus 35322		8	5A	Ba15d	
MI-582	7582	claire	12	25	Ba15s	50 / 319
MI-276	30X48/C6	claire	24	20	Ba15d	500 / 324
MI-229	Olympus 35343	dépolie/miroir latéra	220	20	BA15d	321
MI-279	O-3623	claire	220	20	E27	500 / 317
MI-284	C30Small/C	claire	220	20	Ba15d	300 / 322
MI-288	O-3561	dépolie/miroir latéra	220	20	Ba15d	100 / 325
MI-285		claire	220	30	E27	500 / 317
MI-280	0-3989	claire	235	15	Ba15d	300 / 325
MI-278	O-3601	dépolie/miroir latéra	240	20	Ba15d	300 / 321

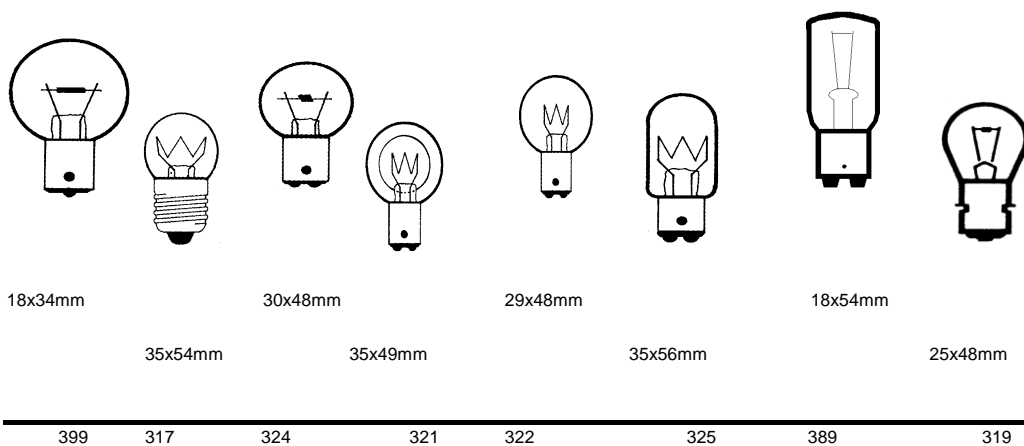

Microscopie : lampes conventionnelles

Code	Références	Tension [Volt]	Puissance [Watt/A]	Culot	Durée de vie (hr)	Figure
MI-275	OP2106	3-6	12	Ba15s	100	331
MI-282	C6ZG13,8	4-6	1,2A	Ba9s	70	329
MI-287	OP2101ze	4-6	1,2A	E10	70	330
MI-251	840605	6	5	Ba9s	50	329
MI-389	70389	6	15	E14		449
MI-274	OP2502	12	5A	Ba15s	100	333
MI-125	12310802	12	25	P17s	300	467
MI-582X		12	25	P30s	600	468
MI-139*	Olympus 35342	120	30	Ba15d		465

* Miroir laréral



467

468

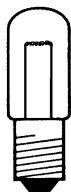

18x54mm

449

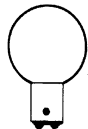

35x59mm

465

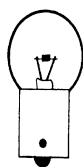

18x35mm

331

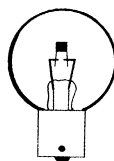

35x61mm

333



15x27mm

329



13x27mm

330

Microscopie : lampes conventionnelles

Code	Références Osram	Tension [Volt]	Puissance [Watt/A]	Culot	Dimensions [mm]	Figure
LO-013	Osram 8013	6	10	Ba15d	25x46	335
LO-014	Osram 8014	6	10	Ba15s	25x46	451
ED-600	Osram 5001	6	10	Ba15s	18x35	451
LO-017	Osram 8017	6	15	Ba15d	19x54	326
LO-018	Osram 8018	6	15	Ba15d	19x52	327
LW-225	Narva 67225	6	15	Ba15d		453
LW-241	Narva 67241	6	15	Z16	19x55	351
LW-251	Narva 67251	6	15	Z16		350
LW-272	Narva 67272 mat	6	15	Z16		350
LW-273	Narva 67273	6	15	Z16		350
LW-411	Narva 67411	6	30	Ba20d		452
LW-461	Narva 67461	6	30	Ba20d		326
LW-471	Narva 67471	6	30	Z16	19x55	350
LO-001	Osram 8001	6	4,35A	E14	35x65	334
LO-100	Osram 8100	6	5A	E14	35x65	470
LO-128	Osram 8128	6	5A	Ba15s	19x55	471
LW-522	Narva 67522	6,3	35	E14		n.c
LO-024	Osram 8024	12	40	Ba20d	35x67	320
LO-022	Osram 8022	12	50	Ba20d	35x69	320
LW-612	Narva 67612	12	50	Ba20d		452
LW-622	Narva 67622	12	50	Ba20d		n.c
LO-032	Osram 8032	12	100	P28s	28x135	311
LW-822	843146	12	100	S20s	60x92	397
LO-029	Osram 8029	15	60	Ba20d	35x67	320
LO-203	Osram 8203	25	1A	Ba15s	19x52	471

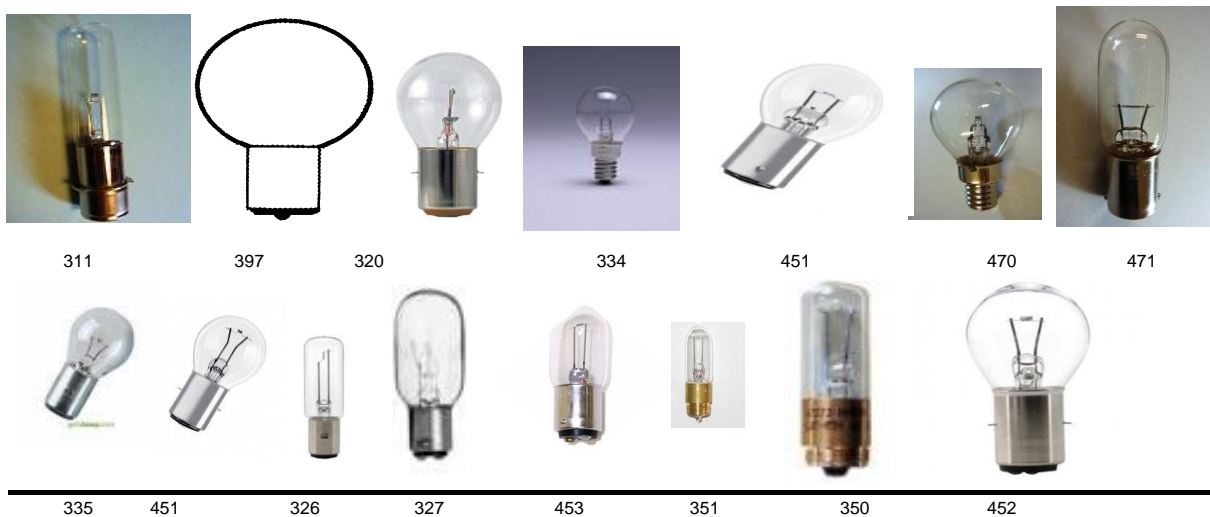

Microscopie : lampes à décharge

Code	Références			Puissance [Watt]	Durée de vie [hrs]	Figure
	Osram	Zeiss	Leica-Leitz			
QL-0050	HBO 50W/ACL1	390198	Leitz 500-137 L	50	100	312
QL-0051	HBO 50W/ACL2		Leitz 500-137 L	50	100	312
QL-0053	HBO 50W/3			50	200	312
XL-0075	XBO 75W/2	381619	Leitz 500-139	75	400	314
QL-0102	HBO 100W/2	381602	Leitz 500-138	100	200	314
QL-0103	HBO 103W/2			100	300	314
QL-0203	HBO 200W/2L1	380044	Leitz 500-016	200	200	313
QL-0204	HBO 200WL 2			200	200	313
QL-0233	HBO 200W 3 électrodes			200		nc
QL-0209	HBO 200W/4 L1			200	200	315
QL-0206	HBO 200W/DC			200	1000	313
XL-0151	XBO 150W/1	380018	Leitz 500-008	150	1200	314
XL-0300	XBO-R300W/60COFR			300	1000	392
XL-0453	XBO450W/OFR		Leitz 500-031	450	2000	450
320XCITE	MERCURE 120W X-CITE			120	2000	365
HXP-120	HXP-R 120W/45C VIS			120	2000	364

lampes soumises à éco-contribution



392



364



365



312



313



314



315



450

Lampes d'examen HEINE D' origine

Code	Réf; HEINE	Tension [Volt]	Type appareil
HO-132/92	X.01.88.032	2,5	Ophtalmoscope
HO-134/92	X.01.88.034	2,5	Ophtalmoscope loupe éclairante, Dermatoscope
HO-135/92	X.01.88.035	2,5	Laryngoscope fibre optique, Proctoscope
HO-137/92	X.01.88.037	2,5	Otoscope miroir laryngé
HO-138/92	X.01.88.038	2,5	Ophtalmoscope loupe éclairante, Dermatoscope
HO-139/92	X.01.88.039	2,5	Ophtalmoscope FOCALUX
HO-140/92	X.01.88.040	2,5	Proctoscope
HO-141/92	X.01.88.041	2,5	Otoscope mini Fibrilux, mini 2000
HO-142/92	X.01.88.042	2,5	Ophtalmoscope mini 2000 FOCALUX
HO-143/92	X.01.88.043	2,5	Ophtalmoscope ALPHA
HO-156/92	X.01.88.056	2,5	Otoscope minilux, mini 2000
HO-157/92	X.01.88.057	2,5	Otoscope miroir laryngé droit
HO-158/92	X.01.88.058	2,5	Skiascope HSR2
HO-159/92	X.01.88.059	2,5	Laryngoscope éclairage conventionnel
HO-169/92	X.01.88.069	2,5	Ophtalmoscope BETA 200
HO-177/92	X.01.88.077	2,5	Rétinoscope, Otoscope BETA 200
HO-184/92	X.01.88.084	2,5	Ophtalmoscope K180
HO-187/92	X.01.88.087	2,5	Skiascope à fente BETA 200
HO-188/92	X.01.88.088	2,5	Skiascope à spot BETA 200
HO-194/92	X.01.88.094	2,5	Stylo lampe clip light
HO-198/92	X.01.88.098	2,5	Ophtalmoscope lampe à fente
HO-1105/92	X01.88.105	2,5	Mini 3000 FO
HO-1106/92	X01.88.106	2,5	Ophtalmoscope Mini 3000
HO-1107/92	X01.88.107	2,5	Lampe à clip et lampe combinée Mini 3000
HO-1108/92	X01.88.108	2,5	Lampe à clip Mini C
HO-1109/92	X01.88.109	2,5	Dermatoscope Mini 3000
HO-1110/92	X01.88.110	2,5	Otoscope Mini 3000
HO-244/92	X.02.88.044	3,5	Laryngoscope F.O, proctoscope
HO-246/92	X.02.88.046	3,5	Ophtalmoscope loupe éclairante, Dermatoscope
HO-247/92	X.02.88.047	3,5	Ophtalmoscope examen
HO-248/92	X.02.88.048	3,5	Skiascope HSR2
HO-249/92	X.02.88.049	3,5	Otoscope miroir laryngé
HO-250/92	X.02.88.050	3,5	Ophtalmoscope indirect
HO-251/92	X.02.88.051	3,5	Proctoscope
HO-253/92	X02.88.053	3,5	
HO-262/92	X02.88.062	3,5	
HO-263/92	X.02.88.063	3,5	Laryngoscope
HO-270/92	X.02.88.070	3,5	Ophtalmoscope BETA 200
HO-278/92	X.02.88.078	3,5	Otoscope BETA, Rétinoscope LAMBDA
HO-286/92	X.02.88.086	3,5	Ophtalmoscope K180
HO-289/92	X.02.88.089	3,5	Skiascope à fente BETA 200
HO-290/92	X.02.88.090	3,5	Skiascope à spot
HO-291/92	X.02.88.091	3,5	Ophtalmoscope FOCALUX
HO-299/92	X02.88.099	3,5	Lampe à fente à main
HO-2101/92	X02.88.101	3,5	Ophtalmoscope et lampe FOCALUX ALPHA +
HO-2102/92	X02.88.102	3,5	Ophtalmoscope ALPHA +
HO-460/92	X.04.88.060	6	Anoscope ATE, Rectoscope-Proctoscope RTE
HO-468/92	X.04.88.068	6	Ophtalmoscope indirect OMEGA
HO-476/92	X04.88.076	6	Ophtalmoscope indirect SIGMA 100
HO-480/92	X04.88.080	6	Microspot pour lunette loupe
HO-481/92	X.04.88.081	6	Ophtalmoscope indirect
HO-493/92	X.04.88.093	6	Ophtalmoscope indirect SIGMA 150
HO-4104/92	X04.88.104	6	Casque omega 500
HO-4111/92	X04.88.111	6	Casque omega 500 5w

Lampes d'examen HEINE compatible

Code	Type HEINE	Tension [Volt]	Type appareil
HO-132	X.01.88.032	2,5	Ophtalmoscope
HO-134	X.01.88.034	2,5	Ophtalmoscope loupe éclairante, Dermatoscope
HO-135	X.01.88.035	2,5	Laryngoscope fibre optique, Proctoscope
HO-137	X.01.88.037	2,5	Otoscope miroir laryngé
HO-138	X.01.88.038	2,5	Ophtalmoscope loupe éclairante, Dermatoscope
HO-139	X.01.88.039	2,5	Ophtalmoscope FOCALUX
HO-141	X.01.88.041	2,5	Otoscope mini Fibrilux, mini 2000
HO-142	X.01.88.042	2,5	Ophtalmoscope mini 2000 FOCALUX
HO-156	X.01.88.056	2,5	Otoscope minilux, mini 2000
HO-157	X.01.88.057	2,5	Otoscope miroir laryngé droit
HO-159	X.01.88.059	2,5	Laryngoscope éclairage conventionnel
HO-169	X.01.88.069	2,5	Ophtalmoscope BETA 200
HO-177	X.01.88.077	2,5	Rétinoscope, Otoscope BETA 200
HK-137	X01.88.037	2,5	Otoscope miroir laryngé
HK-141	X01.88.041	2,5	Otoscope mini Fibrilux, mini 2000
HK-142	X01.88.042	2,5	Ophtalmoscope mini 2000 FOCALUX
HK-156	X01.88.056	2,5	Otoscope minilux, mini 2000
HK-157	X01.88.057	2,5	Otoscope miroir laryngé droit
HK-159	X.01.88.059	2,5	Laryngoscope éclairage conventionnel
HO-244	X.02.88.044	3,5	Laryngoscope F.O, proctoscope
HO-246	X.02.88.046	3,5	Ophtalmoscope loupe éclairante, Dermatoscope
HO-247	X.02.88.047	3,5	Ophtalmoscope examen
HO-249	X.02.88.049	3,5	Otoscope miroir laryngé
HO-251	X.02.88.051	3,5	Proctoscope
HO-262	X.02.88.062	3,5	Otoscope miroir laryngé courbé
HO-270	X.02.88.070	3,5	Ophtalmoscope BETA 200
HO-278	X.02.88.078	3,5	Otoscope BETA, Rétinoscope LAMBDA
HO-286	X.02.88.086	3,5	Ophtalmoscope K180
HO-468	X.04.88.068	6	Ophtalmoscope indirect OMEGA

Lampes d'examen WELCH ALLYN

Code	Réf.	Tension	Type appareil	Fig.
WA-025	02500	6	Examen	354
WA-026	02600	6	Examen	355
WA-028	02800		Rétinoscope	326
WA-030	03000	3,5	ophtalmoscope,rétinoscope,otoscope,laryngoscope	340
WA-031	03100	3,5	ophtalmoscope,otoscope,laryngoscope	408
WA-034	03400	2,5	Otoscope,rétinoscope	326
WA-037	03700	2,5	Skiascope	327
WA-039	03900	2,5	Ophtalmoscope	328
WA-041	04100	14,5	Examen	329
WA-042	04200		Examen	303
WA-044	04400	2,5	Ophtalmoscope	411
WA-045	04500	3,5	Rétinoscope	340
WA-047	04700	2,5	Laryngoscope enfant	414
WA-048	04800	2,5	laryngoscope adulte	409
WA-049	04900	3,5	Ophtalmoscope	411
WA-060	06000	2,5	Laryngoscope	412
WA-061	06100	14,5	Examen	330
WA-062	06200	3,5	Audioscope	331
WA-065	06500	3,5	Otoscope	n.c
WA-076	07600	2,5	Stylo Penlite	332
WA-078	07800	6	Gynécologie	333
WA-082	08200	3,5	Rétinoscope	334
WA-083	08300	3,5	Rétinoscope	335
WA-085	08500	3,6	Examen	336
WA-095	09500	24	Illuminateur	338
WA-M21E001	M21E001	21W		339

lampes soumises à éco-contribution



Lampes d' examen

Code		Tension [Volt]	Puis. [Watt]	Culot	Dim [mm]	Fig.
Lampe frontale						
KO-041	Lampe frontale	2,25	0,56	E10	10x22	433
MR-24004007	Lampe frontale	3,5	0,7	E10	11X24	365
KO-001	Effner - Clar	4	6	E10	15x27	354
KO-013	Lampe frontale	4	6	E10	12x25	365
KO-045	Lampe frontale	6		E10	15x28	354
KO-044	Lampe frontale	6		E10	18x31	354
KO-004	Lampe frontale	6	4	E10	15x27	354
KO-002	Clar - Storz	6	6	E10	15x27	354
KO-008	Lampe frontale	6	6	Ba9s	15x28	355
KO-012	Oculus	6	6	E10	12x25	365
KO-003	Clar	6	10	E10	15x27	354
KO-709	Eclairage frontal Clar 709	8/10	3,5/5	E10	15X27	354
KO-710	Eclairage frontal Clar - Oc	9		E10	15X27	354
MR-29012060	Lampe frontale	12	6	E10	15X28	365
Fronto- focomètre						
MI-3900	TOPCON LM25 (clair)	230	15	E27	35X55	352
MI-3910	TOPCON (dépoli)	230	15	E27	35X55	352
3899/CH		230	20	E16	30X48	n.c
Lampes à FENTE						
OQ-750	HAAG-STREIT HS940-7E	6	4,5A	P40S	34X63	400
OQ-930	HAAG-STREIT HS900-9E	6	4,5A	P44S	35X65	402
MI-122	SL1E/2E/3F/7F/2D	6	20	G4 platine		411
OQ-900	HAAG-STREIT BC900	12	30	spécial		n.c
Laryngoscope						
KO-005	Colson 0.13560	2,5		Dépoli/joint		409
KO-066	Foregger-Miller EF1AR E1	2,5		Dépoli/joint	5X20	414
KO-068	Foregger-Miller EF1 Enfa	2,5		clair	5X20	414
KO-069	Foregger-Miller EF4 adult	2,7		dépoli	7X25	414
KO-046	MC Intosch EF171	2,7		dépoli/ ressort	5x20	446
KO-047	MC Intosch	2,7		dépoli/ ressort	5,5x18	409
KO-170	MC Intosch EF170	2,7		clair	5,5x18	414
KO-171	MC Intosch EF170	2,7		dépoli	5,5x18	414
KO-172	Penlon 55091	2,7		clair/joint	5x19	408
KO-092	Penlon 55092	2,5		Dépoli/joint	4x14	410
KO-018	Penlon 55094	2,7		clair	6x20	n.c
KO-020	Riester 11381 adulte	2,7		di/joint/ressort		414
KO-021	Riester 11380 enfant	2,5		di/joint/ressort		414
8546XA	Storz	2,5				



411



352



402



400

Lampes d' examen

Code		Tension	Culot	Dim	Figure
Ophthalmoscope					
KO-676	Luneau 12.36.76	3,8		10x22	n.c
KO-618	Luneau 13.60.18	3,5			365
HO-894	Luneau 14.48.94	3,5		15x25	n.c
KO-367	Luneau 17.23.67	2,5			n.c
KO-065	Otoscope Riester 10600	2,5		6x20	410
KO-042	Frenzel EFF68	3,8		4,5x17	408
KE-1203	Keeler indirect 1012-P7003	3,5			n.c
KE-1303	Keeler skiascope 1013-P-7003	3,5		8x20	415
KE-1363	Keeler skiascope 1013-P-7007	3,5		8x30	341
KE-1309	Keeler rétinoscope 1013-P-7009	3,6			342
KE-1531	Keeler otoscope 1015-P-7031	2,8			n.c
KE-1558	Keeler otoscope 1015-P-7058	3,5			n.c
KE-1566	Keeler otoscope 1015-P-7066	2,8			n.c
KE-7034	Keeler indirect 1011-P-7034	3,5			343
KE-7042	Keeler 1011-P-7048	2,8			n.c
KE-7156	Keeler tonomètre 1024-P.	2	6		n.c

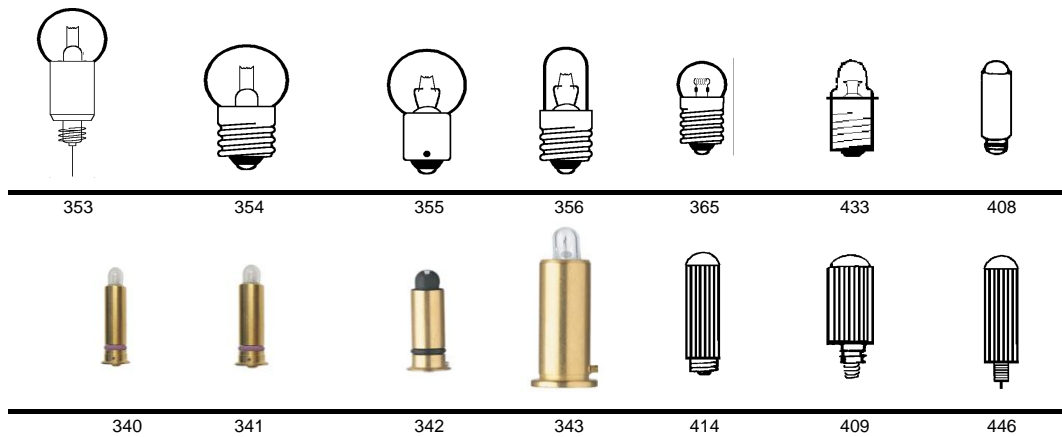

Lampes pour application dentaire
Avec miroir dichroïque

Code	Références Osram / Philips	Tension [Volt]	Puissance [Watt]	Culot	Durée de vie [hrs]	Figure
KL-528	13528	6	15	GZ4	750	303
KL-020	64255 / 13390	8	20	G4	50	341
KL-021	JCR/M	6	20	GZ4		306
KL-298	13298	10	52	GZ4	25	303
KL-013	64613	12	75	G5,3-4,8	25	341
KL-014	64614	12	75	G5,3-4,8	25	341
KL-016	64617S	12	75	G5,3-4,8	25	341
KL-017	64617 / 13865	12	75	G5,3-4,8	25	341
KL-035	64624	12	100	G5,3-4,8	25	341
KL-165	13165	14	35	G4	50	341
KL-150	64634HLX / 6423	15	150	GZ6,35	50	303



50x42mm

303



35x35mm

341



35x33mm

306

Lampes pour application dentaire
A culot métallique

Code	Références Osram	Tension	Puissance (Watt)	Culot	Durée de vie [hrs]	Figure
JQ-012	64222	6	10W	PG22	300	309
OS-111	64111	12	5W	Ba9s	240	375
OS-113	64113	12	10W	Ba9s	240	375
JQ-030	64261	12	30W	G6,35	50	301
JQ-032	64260	12	30W	PG22	50	309
JQ-052	64609HLX	12	50W	PG22	50	309
OS-150	64150	12	55W	P14,5s	150	343
OS-151	64151	12	55W	PK22s	150	342
JQ-122	64626HLX	12	100W	PG22	50	309
OS-193	64193	12	60/55W	P43t		386
OS-156	64156	24	70W	PK22s		342
DZE/FDS	64643	24	150W	GY9,5	100	457
JQ-249	64642HLX	24	150W	G6,35	300	301
HF-317	64317		45W 6,6A	PK30d	1000	346
HF-340	64340		100W 6,6A	R7S	1000	304
HF-341	64341HLX		100W 6,6A	PKx30d	1000	345
HF-001	64342HLX		100W 6,6A	PK30d	1000	344
HF-382	64382HLX		200W 6,6A	PK30d	1000	344

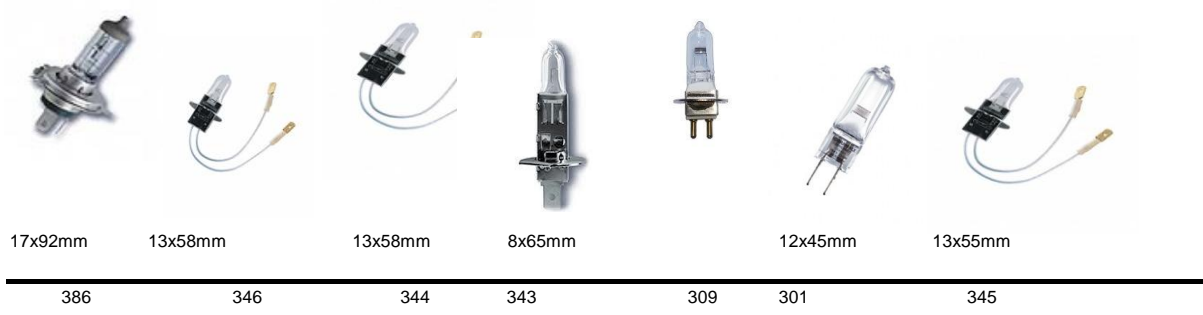
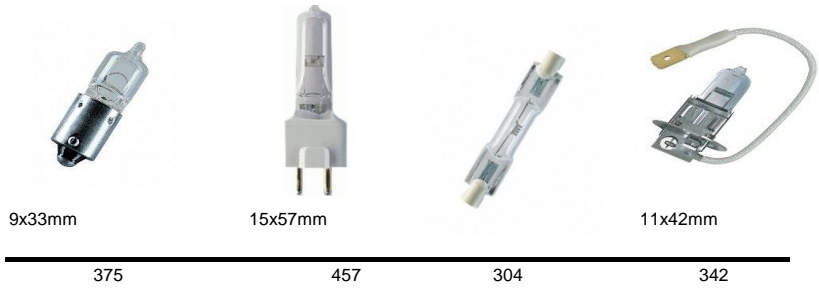

Lampes à rayons ultraviolets

Code	Références	Longueur d'onde	Puiss. [Watt]	Culot	Dim. [mm]	Figure
Tubes germicides						
SB-004	TUV4W	UVC254nm	4	G5	150	462
TUV6W-E	TUV 6W		6	E27		n.c
SB-006	TUV6W	UVC254nm	6	G5	226	462
SB-008	TUV8W	UVC254nm	8	G5	288	462
SBC-009	PLS9W TUV	UVC254nm	9	G23	167	459
SBC-011	PLS11W TUV	UVC254nm	11	G23	236	459
SB-015	TUV15WLL	UVC254nm	15	G13	438	462
SBC-018	PLL18WTUV	UVC254nm	18	2G11	225	393
SB-683	56075683 / NN15/44	UVC254nm	15	G13	435	462
SB-025	TUV25W	UVC254nm	25	G13	452	462
SB-030	TUV30WLL	UVC254nm	30	G13	895	462
SB-036	TUV36W	UVC254nm	36	G13	1213	462
SBC-036	PLL36WTUV	UVC254nm	36	2G11	415	393
SB-055	TUV55WHO	UVC254nm	50	G13	895	462
SB-075	TUV75WHO	UVC254nm	75	G13	1213	462
SB-115	TUV115RVHO	UVC254nm	115	G13	1213	462
Tubes lumière noire						
BLB-004	TL4W/08	UVA 366nm	4	G5	136	463
BLB-006	TL6W/08	UVA 366nm	6	G5	212	463
BLB-008	TL8W/08	UVA 366nm	8	G5	290	463
BLB-009	PLS-9W/08	UVA 366nm	9	G23	130	459
BLB-015	TLD15W/08	UVA 366nm	15	G5	437	463
BLB-018	TL-D18W/08	UVA 366nm	18	G13	600	463
BLB-036	TL-D36W/08	UVA 366nm	36	G13	1200	463
BLB-125	HPW125WT	UVA 366nm	125	E27	177	460
BLB-160	MLW160W	UVA 366nm	160	E27	177	460
BLB-400	H400BL	UVA 366nm	400	E40		460
Tubes UVA - UVB						
FLUV-10009	F85/100WPUVA		100	G13		462
WM-100012	F85100W-UV6	UVB306nm	100	G13		462
FLUV-15009	F15T8-PUVA		100	G13		462
WM-15012	F15T8-UVB	UVB 312nm	15	G13	438	462
FLUV-08009	F8T5-PUVA		8	G5		462
WM-08012	F8T5-UVB	UVB 312nm	8	G5	303	462
WM-10001D	TL100W/01	UVB	100	R17D	1760	462

lampes soumises à éco-contribution

Lampes à rayons ultraviolets

Code	Références	Longueur d'onde	Puiss. [Watt]	Culot	Dim. [mm]	Figure
Tubes CLEO avec réflecteur						
FLCL-40R		UV 310 à 400nm	40	G13	590	462
FLCL-80R		UV 310 à 400nm	80	G13	1500	462
FLCL-100R		UV 310 à 400nm	100	G13	1764	462
Tubes CLEO sans réflecteur						
FLCL-40		UV 310 à 400nm	40	G13	590	462
FLCL-80		UV 310 à 400nm	80	G13	1500	462
FLCL-100		UV 310 à 400nm	100	G13	1764	462
Tubes (400 à 480 nm) super actinique						
FLUV-14003	TL 140W/03		140	G13	1500	462
FLUV-20003RS	TL 20W/03		20	G13	590	462
FLUV-40003RS	TL 40W/03		40	G13	1200	462
Tubes actiniques						
FLUV-04005	TL4W/05	360nm		G5	136	462
FLUV-06005	TL6W/05	360nm		G5	212	462
FLUV-15005	TL15W/05	360nm		G13	438	462
FLUV-20005	TL20W/05	360nm		G13	590	462
FLUV-30005K	TLDK30W/05	360nm		G13	438	462
FLUV-40005K	TLK40W/05	360nm		G13	590	462
FLUV-40005	TL40W/05	360nm		G13	1200	462
STARTER						
ST-111	S 10		4/80W			415
S2	S 2		4/22W			415
ST-192	ST 192					415
S25	S25 STARTER CLEO					415

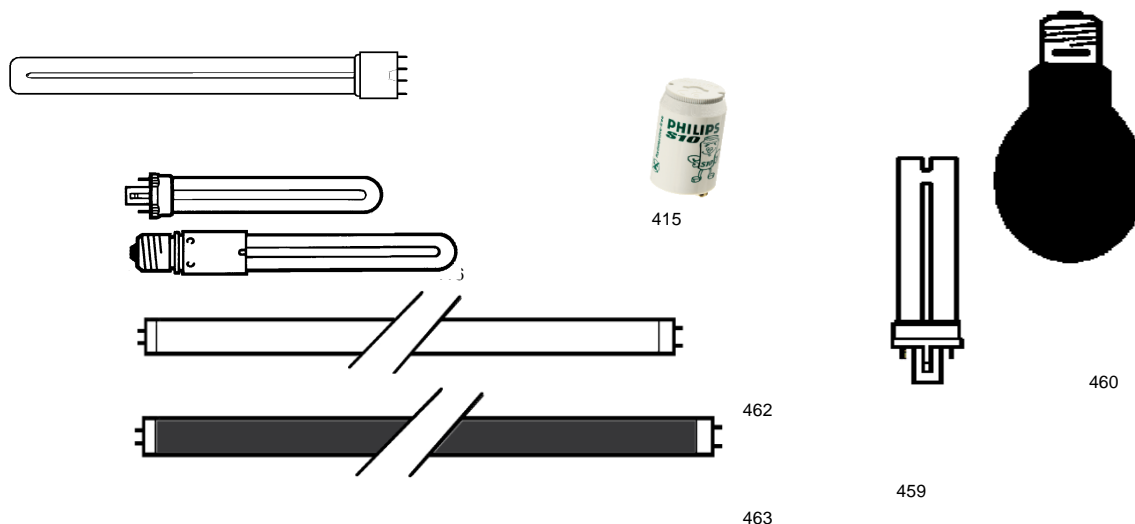

lampes soumises à éco-contribution

Lampes pour Photo-Thérapie

Code	Références	Puiss. [Watt]	Culot	Dim. [mm]	Durée de vie [hrs]	Figure
FKLA-18830	Dulux L18W/31	18	2G11	209	10000	393
EXN	41870 WFL	50	GX5,3	50x45	3000	306
DDL	14501	150	GX5,3	50x45	500	306
FKUV-09071	DULUX S9W/71	9	G23	168		459
FKSA-11840	DULUX S9W/21	11	G23	238	10000	459
FKLA-18950	DULUX L18W/12	18	2G11	217	10000	393
FKUV-18071	DL18W/71 (1)	18	2G11	225		393
FLLA-18965	L18W/72**	18	G13	590	10000	378
FLUV-20052	TL 20W/52	20	G13	600	2000	378
FLLA-36965	L36W/72**	36	G13	1200	10000	378
FLLA-58965	L58W/72**	58	G13	1500	10000	378
UV-300	Ultra Vitalux HCR300-280	300	E27	185	1000	381
UM-400	Ultramed400W	400	R7s	104	1000	382
HPA400S	HPA400S	400	R7s	118	750	382
RS-402*	MHL STRAHLER 56033065		R7s	105		382

* Nous recommandons l'originale Heraeus

** Application SAD

(1) Bilibeb- Drager 4000

lampes soumises à éco-contribution

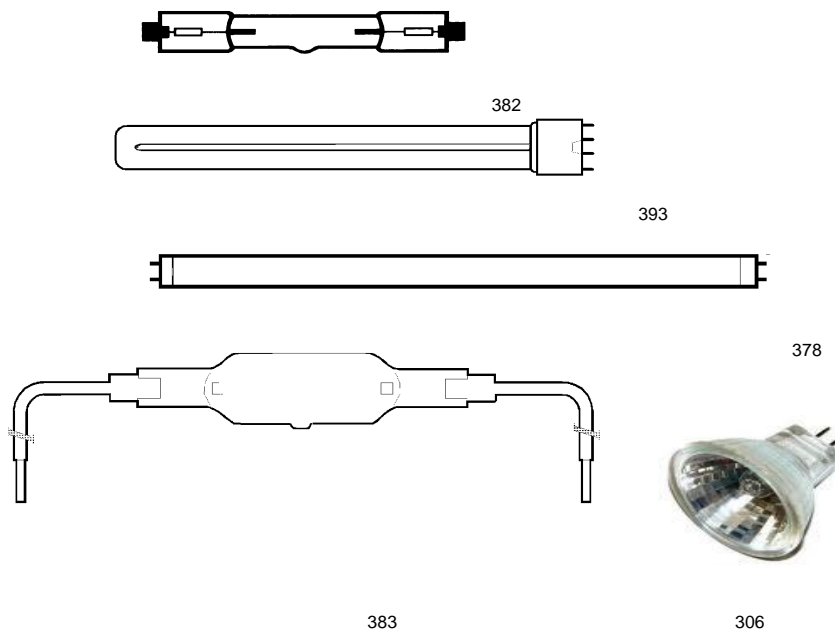

Lampes à rayonnement infrarouge

Code	Références Osram / Philips	Tension [Volt]	Puiss. [Watt]	Culot	Durée de vie[hrs]	Fig.
TH-150	PAR38E INFRAFIL	230	150	E27	5000	379
SI-150*	Sicca L/R 150W	230	150	E27	5000	381
SI-176	IR175CPAR38	230	175	E27	5000	379
TH-250	Thera 250W	230	250	E27	5000	380
SI-250	Sicca IR 250SR125	230	250	E27	5000	381
SI-251*	Sicca L/R IR 250 R125				5000	381
HL-554	Sollux / 56018554	230	300	B22d		373
HL-150	sollux 56053026	230	450			n.c
HL-001	Sollux / 56007550	230	150	E27		379
SI-252	Sicca L cl IR250SR125	230	250	E27	5000	380
SI-375	Sicca L claire	230	375	E27	5000	380

*rouge

SI : SICCATHERM

TH: THERATHERM

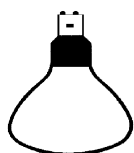

373



379



380



381

Lampes pour visionneuse de Radiographie - Négatoscope

Code	Références Osram Philips	Tension [Volt]	Puiss. [Watt]	Culot	Dim. [mm]	Figure
JQ-100	64625HLX / 7023FCR	12	100	GY6,35	50	305
62138	62138HLX	12	100	GZ6,35	50	366
JQ-240	64640HLX / 7158FCS	24	150	G6,35	50	301
EL-254	JD 2023 M7	220	250	E14	15x81	395
HE-251	64479AM	220	250	Ba15d	18x98	376
FLLA-04640	TLD 4W/640		4	G5	136	378
FLLA-06640	TLD 6W/640		6	G5	212	378
FLLA-08840	TLD 8W/640		8	G5	288	378
FLLA-13640	TLD 13W/640		13	G5	517	378
FLLA-15865	TLD 15W/54		15	G13	430	378
FLLA-18840	TLD 18W/840		18	G13	590	378
FLLA-18865	TLD 18W 865		18	G13	590	378
FLLA-18965	TLD 18W 965		18	G13	590	378
FLLA-30865	TLD 30W/865		30	G13	890	378
FLLA-36840	TLD 36W/840		36	G13	1200	378
FLLA-36865	TLD 36W 865		36	G13	1200	378
FLLA-36965	TLD 36W 965		36	G13	1200	378
FLLA-58840	TLD 58W/840		58	G13	1500	378
FLLA-58865	TLD 58W 865		58	G13	1500	378
FLLA-58965	TLD 58W 965		58	G13	1500	378
FLRI-22865	FC8 T9D		22	G10Q	29X216	379
FLRI-32865	FC12 T10D		32	G10Q	32X307	379
FLRI-40865	FC16 T10D		40	G10Q	32X409	379

lampes soumises à éco-contribution



378

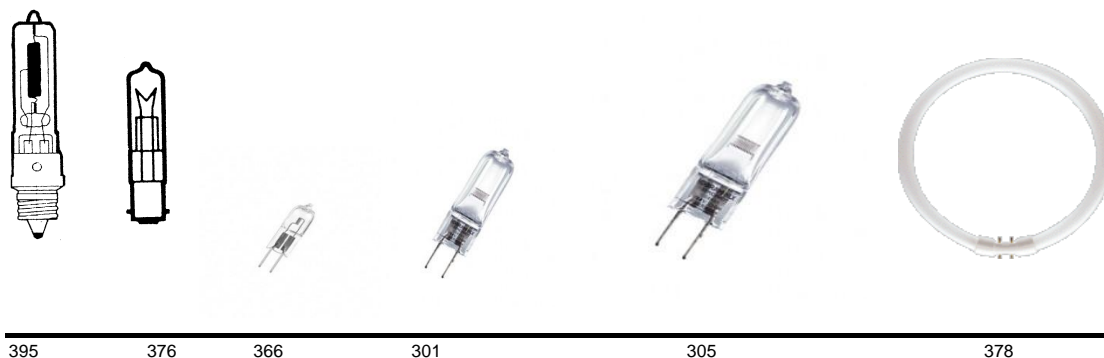

395

376

366

301

305

378

**Lampes pour instrumentation de laboratoire
Biochimie et analyseur de Biochimie**

Code	Références Osram / Autres	Tension [Volt]	Puiss. [Watt]	Culot	Dim. [mm]	Figure
JQ-010	64223 / 5972	6	10	G4	8x38	308
KL-010	JCRM H20-3	6	10	GZ4		303
MI-063	O 3113/601034	6	18	Ba15s	18x35	399
EH-620	64250HLX / 7388ESB	6	20	G4	9x31	308
MR-1974	32780	6	20	Cablée	29	436
ME-122	NK-55131 Hitachi	6	20	Spécial/cablée		447
EFM	64607	8	50	GZ6,35	50x42	303
DZA	37346	10,8	30	G5,3	10x51	377
EKZ	36902	10,8	30	GX5,3	50x45	306
FTD	44890WFL	12	20	G4	35x45	303
ME-120	705-0840 Hitachi	12	20	Spécial/cablée	9x40	394
KL-075	64615HLX / 6853EFN	12	75	GZ6,35	50x42	303
FDT	64628 / 5973	12	100	GY9,5	15x57	374
JQ-122	64626HLX / 6839C	12	100	PG22	4x48	309
EPZ	13189	13,8	50	GX5,3	50x45	306
SQ-043	ST43/1 HGE4		1A	Pico9		398

lampes soumises à éco-contribution

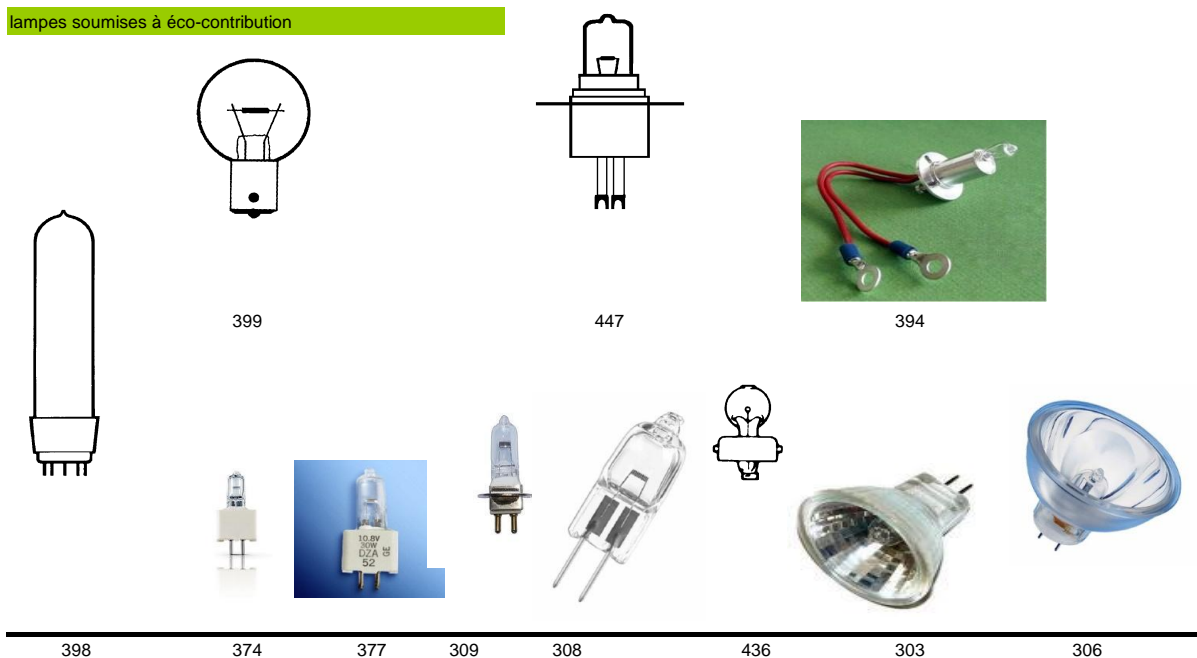

Lampes pour instrumentation de laboratoire

Code	Références	Tension [Volt]	Puiss. [Watt]	Puiss. [Watt]	Durée de vie [hrs]	Figure
Lampes au Xénon						
XL-0075	XBO 75W/2	14	75	75	400	314
XL-0076	XBO 75W/2OFR	14	75	75	400	314
XL-0100	XBO 100W OFR	14	100	100	500	314
XL-0102	XBO-R 100W/45	14	100	100	500	390
XL-0103	XBO-R 100W/45C	14	100	100	500	391
XL-0151	XBO 150W/1	20	150	150	1200	347
XL-0151/13	UXL150S Ushio	20	150	150	1200	347
XL-0153	XBO 150W/CROFR	17,5	150	150	1200	347
XL-0152	XBO150W/1OFR	20	150	150	1200	347
XL-0154	XBO150W/4 Suprasil	20	150	150	1200	347
XL-0180	XBO-R 180W/45	14	180	180	500	390
XL-0185	XBO-R 180W/45C	14	180	180	500	391
XL-0254	XBO250W/4	13	250	250	1200	388
XL-0450	XBO 450W	17	450	450	2000	388
XL-0451	XBO 450W/1	17	450	450	800	388
XL-0452	XBO 450W/2 OFR	17	450	450	2000	388
XL-0453	XBO 450W OFR	17	450	450	2000	388
XL-0454	XBO 450W/4	17	450	450	2000	388
Lampes à vapeur de mercure						
QL-0050	HBO 50W/ACL1	39/45	50	53	100	312
QL-0053	HBO 50W/3	23	50	53	200	312
QL-0102	HBO 100W/2	20,5	100	90	200	314
QL-0112	USH 102D Ushio	20,5	100	90	200	314
QL-0103	HBO 103W/2	22,5	100	90	300	314
QL-0104	HBO-R 103W/45	22,5	100	81,5	300	390
QL-0200	HBO 200W L1	57	200	108	200	314
QL-0203	HBO 200W/2L1	200	128	200		347
QL-0209	HBO 200W/4 L1	200	128	200		347

lampes soumises à éco-contribution



390



HBO 200W/4



391



312



314



HBO 200/2
347



388

**Lampes pour instrumentation de laboratoire
 Xénon compactes**

Code	Références Perkin Elmer	Tension [Volt]	Puiss. [Watt]	Dim. [mm]	Durée de vie [hrs]	Figure
CE-125	PE125BF	11	125	32X50	500	352
CE-126	PE125BUV	11	125	32X50	500	352
CE-150	PE150BF	12	150	32x50	500	352
CE-151	PE150A-10F	11,7	150	26X40	500	352
CE-152	PE150AF	11,7	150	26X40	500	352
CE-175	PE175BF	12,5	175	32x50	500	352
CE-176	PE175-BUV	12,5	175	32x55	500	352
CE-178	PE175B-10UV	12,5	175	32x55	500	352
CE-305	PE300BF-10F	13,5	300	32x55	500	352
CE-303	PE 300BF	14	300	32x50	500	352
CE-304	PE300BUV	14	300	32x50	500	352
CE-307	PE300C-10F	13,5	300		500	352
CE-500	PE500C-10F	15,5	500		500	352
CE-501	PE500DF	18,5	500	65X72	500	352
CE-502	PE500C-13F	15,5	500		500	352

lampes soumises à éco-contribution

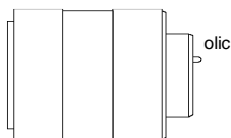

Type B Parabolic

type D Parabolic

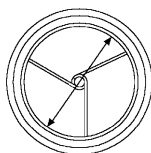

Type B Elliptical



Type C Elliptical

352

Endoscopie : Lampes à décharge

Code	Références Perkin elmer	tension [Volt]	Puiss. [Watt/A]	Durée de vie [hrs]	Dim. [mm]	Fig.
CE-150	PE150BF	12	150	500	32x50	352
CE-175	PE175BF	13	175	500	32x50	352
CE-305	PE300BF-10F	13,5	300	1000	32x55	352
CE-303	PE 300BF	14	300	500	32x50	352
CE-304	PE300BUV	14	300	500	32x50	352
Osram						
LAMPES XENON - REFLECTEUR						
XL-0102	XBO-R 100W/45	14	100	500	67x83	390
XL-0103	XBO-R 100W/45C	14	100	500	67x83	391
XL-0101	XBO-R 101W/45C	13,6	100	500	67x83	391
XL-0180	XBO-R 180W/45	14	180	500	67x83	390
XL-0181	XBO-R181W/45C	14	180	500	67x83	
XL-0181WIS	XBO-R181W/45C WISAP	14	180	500	67x83	
XL-0181LEM	XBO-R181W/45C LEMKE	14	180	500	67x83	393
XL-0185	XBO-R 180W/45C	14	180	500	67x83	391
XL-0300	XBO-R300W/60COFR	17,5	300	1000	82X110	392
QL-0104	HBO-R103W/45	22,5	100	300	67X81	390
WA-095	Welch alllyn 9500	24				338
Module et lampe STRYKER						
CE303MODULOT	MODULE 1338 POUR CIRCON					394
CE303MODULTI	MODULE 1426 avec lampe et timer					394
CE-303	LAMPE STRYKER 6000			PE 300BF		352
CE-303-STRY	MODULE + LAMPE STRYKER 6000					353
CE-314	LAMPE STRYKER 7000			CL300XCF-10F		352
CE-313	RADIATEUR + LAMPE STRYKER 7000					n.c
CE-311	LAMPE STRYKER 8000			CL300C2-10F		352
CE-310	RADIATEUR + LAMPE STRYKER 8000					n.c

lampes soumises à éco-contribution



353

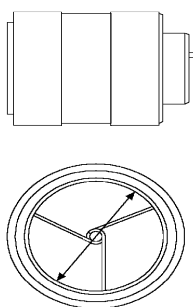

352



393



394



338



392



390



391

Endoscopie : Lampes à décharge

	Références	tension	Puiss.	Durée de	T° couleur	Fig.
HTI - HALOGENURES METALLIQUES						
HTR-255	HTI-250/32	45	270	250	5600	337
HTR-257	HTI-250/32C	45	270	250	5600	364
HTR-257DYO	HTI 250/32 DYONIC	45	250			n.c
HTR-255M3	Stryker3000	45	270			364
HTR-259M4	Stryker4000	45	270			n.c
HTR-259M5	Stryker5000	45	270			n.c
HTR-400	HTI-400/24	55	400	250	5600	364
MA-300	EZM MARC300/16		300	25	5500	338
TIMER						
CE-TMS	Timer 1167					1
CE-TM2Z	compteur horaire					2



454



337



364



338



1



2

Lampes spéciales pour Rétroprojecteurs (OHP)

Code	Références Osram / Philips	Tension [Volt]	Puissance [Watt]	Culot	Durée de vie [hrs]	Figure
JQ-250	HLX64655 / 6958XHP	24	250	G6,35	50	301
JQ-259	HLX64657 / 6958	24	250	G6,35	300	301
JQ-436	HLX64663 / 7787XHP	36	400	G6,35	50	301
HMS-400	HMI 400SE/MSR400HR	67	400	GZZ9,5	650	371
HMS-575	HMI 575 SE/MSR575HR	95	575	G22	750	369
HTD-300	HTI 300W/D5/65	100	300	SFc10-4	750	312
OH-189	64680 / 7389	230	500	GY9,5	75	418
OH-190	5968 EMG	230	500	GY9,5	75	417
OH-164	7764	230	800	GY9,5	75	417
FSY	93591	240	400	GY9,5	50	417
DYR	64686 / GE26895	240	650	GY9,5	50	367

Lampes halogènes

Code	Références Osram	Tension [Volt]	Puissance [Watt]	Culot	Durée de vie [hrs]	Figure
AL-514	64514	120	300	GX6,35	75	368
HE-251	64499ECO	220	205	Ba15d	2000	376
EL-254	JD250	220	250	E14	2000	395
AL-515	64515	220	300	GX6,35	15	368
AL-516	64516	240	300	GX6,35	75	368
BVM	64540	220	650	GX6,35	15	368
AL-175	64575	220	1000	GX6,35	15	367

lampes soumises à éco-contribution

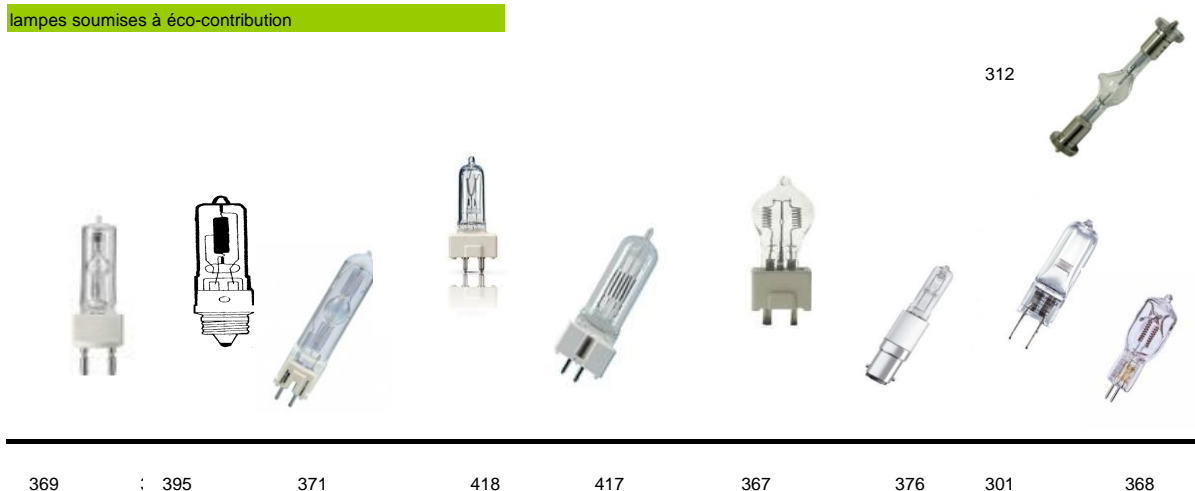

369 ; 395 371 418 417 367 376 301 368

DOUILLES Céramique

Code	Culot	Tension(V)	intensité (A)	T° C (max)	Figure
860	GX5,3 / GZ6,35				1
865R	GZ6,35	250	10	250	2
866R	GX5,3	250	10	250	3
867R	GY5,3	250	10	250	4
881	G6,35 / GZ6,35	250	12,5	250	5
884	G5,3 / GX5,3	250	12,5	350	6
901	G6,35 / GZ6,35 / GY6,35	250	12,5	350	7
905	G6,35 / GY6,35	24	10	180	8
912	G6,35 / GZ6,35 / GY6,35	250	12,5	350	9
913	G6,35 / GZ6,35 / GY6,35	24	12,5	350	10
987	GZ4 / G3,9				11
989	G3,9 / G5,3 / GX5,3	250	12,5	350	12
990	G4 / GY4 / GZ4	50	6	350	13
993	G4	24	4	180	14
994	G4 / GY4 / GZ4	250	10	350	15

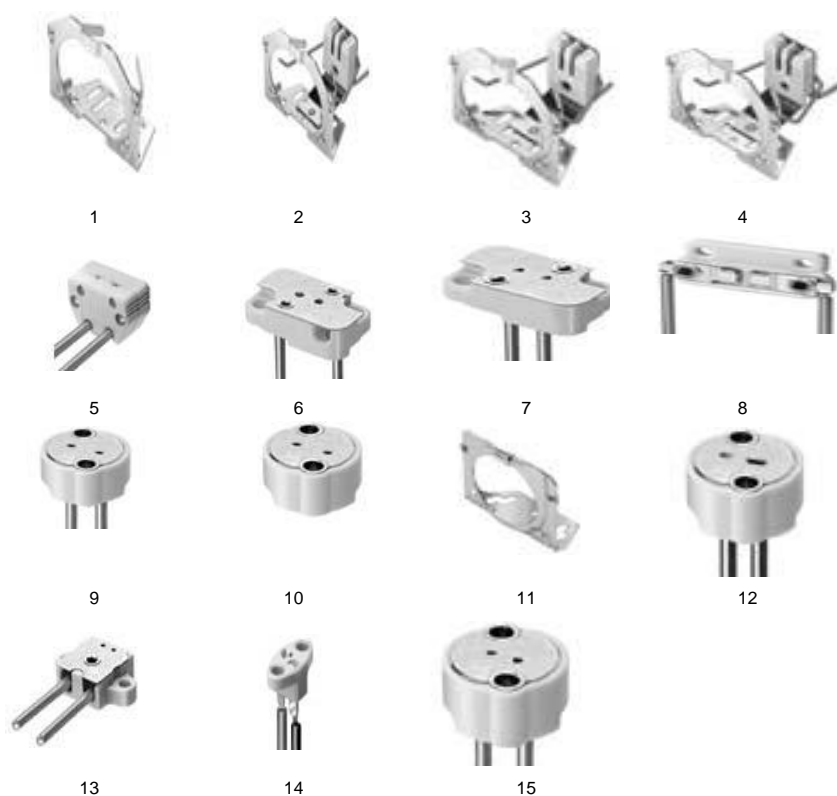

sogeri**LAMPES MINIATURES****LAMPES TUBES**

CODE SOGERI	CODE ABI	Dimensions	Culot	Volt	Ma	Watts
MB-20006003	AM5850	7X20mm	BA7S	6	50	0,30
MB-20006006	AM5880	7X20mm	BA7S	6	100	0,60
MB-20006012	AM5890	7X20mm	BA7S	6	200	1,20
MB-20012006	AM5910	7X20mm	BA7S	12	50	0,60
MB-20012012	AM5940	7X20mm	BA7S	12	100	1,20
MB-20012020	AM5950	7X20mm	BA7S	12	170	2,00
MB-20024006	AM5970	7X20mm	BA7S	24	25	0,60
MB-20024009	AM5980	7X20mm	BA7S	24	40	0,96
MB-20024012	AM5981	7X20mm	BA7S	24	50	1,20
MB-20024019	AM5983	7X20mm	BA7S	24	80	1,92
MB-20024024	AM5985	7X20mm	BA7S	24	100	2,40
MB-20024030	AM5987	7X20mm	BA7S	24	125	3,00
MB-20024040	AM5988	7X20mm	BA7S	24	170	4,00
MB-20048009	AM6000	7X20mm	BA7S	48	20	0,96
MB-20048012	AM6005	7X20mm	BA7S	48	25	1,20
MB-20060012	AM6030	7X20mm	BA7S	60	20	1,20
MB-20060015	AM6035	7X20mm	BA7S	60	25	1,50
MB-22006002	AM5445	7X23mm	BA7S	6	40	0,24
MB-22006003	AM5450	7X23mm	BA7S	6	50	0,30
MB-22006006	AM5470	7X23mm	BA7S	6	100	0,60
MB-22006012	AM5480	7X23mm	BA7S	6	200	1,20
MB-22012006	AM5490	7X23mm	BA7S	12	50	0,60
MB-22012012	AM5510	7X23mm	BA7S	12	100	1,20
MB-22024006	AM5540	7X23mm	BA7S	24	25	0,60
MB-22024009	AM5560	7X23mm	BA7S	24	40	0,96
MB-22024012	AM5570	7X23mm	BA7S	24	50	1,20
MB-22024019	AM5590	7X23mm	BA7S	24	80	1,92
MB-22028006	AM5600	7X23mm	BA7S	28	20	0,60
MB-22030012	AM5610	7X23mm	BA7S	30	40	1,20
MB-22030015	AM5620	7X23mm	BA7S	30	50	1,50
MB-22036007	AM5640	7X23mm	BA7S	36	20	0,72
MB-22036012	AM5650	7X23mm	BA7S	36	35	1,26
MB-22036018	AM5660	7X23mm	BA7S	36	50	1,80
MB-22048009	AM5670	7X23mm	BA7S	48	20	0,96
MB-22048012	AM5680	7X23mm	BA7S	48	25	1,20
MB-22060012	AM5700	7X23mm	BA7S	60	20	1,20
MB-22060024	AM5730	7X23mm	BA7S	60	40	2,40

E10 à loupe

MR-23012002	AB6910	9X23mm	E10	1,2	220	0,26
MR-23025007	AB6920	9X23mm	E10	2,5	300	0,75
MR-23037010	AB6925	9X23mm	E10	3,7	300	1,10
MR-23006006	AB6929	9X23mm	E10	6	100	0,60



LAMPES TUBES 9X23mm

CODE SOGERI	CODE SOGERI	CODE ABI	CODE ABI	Volt	Watts
E10	BA9S	E10	BA9S		
MR-23006006	MB-23006006	AB1010	AB1020	6	0,60
MR-23006012	MB-23006012	AB1030	AB1040	6	1,20
MR-23006020	MB-23006020	AB1050	AB1051	6	2,00
MR-23006030	MB-23006030	AB1054	AB1055	6	3,00
MR-23012006	MB-23012006	AB1064	AB1065	12	0,60
MR-23012015	MB-23012015	AB1070	AB1080	12	1,50
MR-23012020	MB-23012020	AB1090	AB1091	12	2,00
MR-23012030	MB-23012030	AB1094	AB1095	12	3,00
	MB-23024012		AB1104	24	1,20
MR-23024015	MB-23024015	AB1110	AB1120	24	1,50
MR-23024020	MB-23024020	AB1150	AB1160	24	2,00
MR-23024030	MB-23024030	AB1170	AB1180	24	3,00
MR-23030012	MB-23030012	AB1210	AB1220	30	1,20
MR-23030020	MB-23030020	AB1230	AB1240	30	2,00
MR-23030030	MB-23030030	AB1250	AB1260	30	3,00
	MB-23036018		AB1280	36	1,80
MR-23048010	MB-23048010	AB1290	AB1300	48	1,00
MR-23048015	MB-23048015	AB1310	AB1320	48	1,50
MR-23048020	MB-23048020	AB1339	AB1340	48	2,00
MR-23048030	MB-23048030	AB1350	AB1360	48	3,00
MR-23060012	MB-23060012	AB1370	AB1380	60	1,20
MR-23060020	MB-23060020	AB1390	AB1400	60	2,00
MR-23085030	MB-23085030	AB1414	AB1415	85	3,00
MR-23130025	MB-23130025	AB1420	AB1430	130	2,50
MR-23240030	MB-23240030	AB1440	AB1450	240	0,30

Super loupe 10X28mm E10

MR-28001002		AB6950		1,2	200
MR-28002005		AB6955		2,2	250
MR-28002007		AB6960		2,5	300
MR-28003001		AB6965		3,7	300
MR-28003002		AB6967		3,7	500

LAMPES TUBES 10X28mm

CODE SOGERI	CODE SOGERI	CODE ABI	CODE ABI	Volt	Watts
E10	BA9S	E10	BA9S		
MR-28004005		AB1460		4,5	0,50
MR-28004015		AB1470		4,5	1,50
MR-28005005	MB-28005005	AB1472	AB1469	5	0,50
MR-28006003	MB-28006003	AB1473	AB1474	6	0,30
MR-28006006	MB-28006006	AB1475	AB1476	6	0,60
	MB-28006011		AB1477	6	1,10
MR-28006012	MB-28006012	AB1478	AB1479	6	1,20
MR-28006020	MB-28006020	AB1480	AB1490	6	2,00
MR-28006030	MB-28006030	AB1500	AB1510	6	3,00
MR-28006040	MB-28006040	AB1513	AB1514	6	4,00
MR-28006007	MB-28006007	AB1520	AB1530	6,5	0,65
MR-28007010	MB-28006010	AB1540	AB1550	6,5	1,00
MR-28006019	MB-28006020	AB1560	AB1570	6,5	2,00
MR-28007007	MB-28007007	AB1620	AB1630	7	0,70
MR-28007020	MB-28007020	AB1640	AB1650	7	2,00
MR-28012002		AB1660		12	0,20



LAMPES TUBES 10X28mm

CODE SOGERI	CODE SOGERI	CODE ABI	CODE ABI	Volt	Watts
E10	BA9S	E10	BA9S		
MR-28012006	MB-28012006	AB1680	AB1690	12	0,60
MR-28012012	MB-28012012	AB1700	AB1710	12	1,20
MR-28012030	MB-28012030	AB1750	AB1760	12	3,00
	MB-28012040		AB1780	12	4,00
MR-28014011	MB-28014011	AB1782	AB1783	14	1,10
MR-28016030		AB1790		16	3,00
MR-28018018	MB-28018018	AB1800	AB1810	18	1,80
MR-28018030		AB1813		18	3,00
MR-28024012	MB-28024012	AB1820	AB1825	24	1,20
MR-28024020	MB-28024020	AB1830	AB1840	24	2,00
MR-28024030	MB-28024030	AB1860	AB1870	24	3,00
MR-28024040	MB-28024040	AB1880	AB1890	24	4,00
MR-28026020	MB-28026020	AB1893	AB1894	26	2,00
MR-28027020	MB-28027020	AB1896	AB1897	27	2,00
MR-28028011	MB-28028011	AB1900	AB1910	28	1,00
	MB-28028028		AB1920	28	2,80
	MB-28028048		AB1930	28	4,80
MR-28030015	MB-28030015	AB1940	AB1950	30	1,50
MR-28030030	MB-28030030	AB1960	AB1970	30	3,00
MR-28036018	MB-28036018	AB2040	AB2050	36	1,80
MR-28036030	MB-28036030	AB2060	AB2070	36	3,00
MR-28048020	MB-28048020	AB2100	AB2110	48	2,00
MR-28048024	MB-28048024	AB2140	AB2150	48	2,40
MR-28048030	MB-28048030	AB2160	AB2170	48	3,00
MR-28048040	MB-28048040	AB2190	AB2200	48	4,00
MR-28052030	MB-28052030	AB2214	AB2215	52	3,00
MR-28060012	MB-28060012	AB2220	AB2230	60	1,20
MR-28060020	MB-28060020	AB2240	AB2250	60	2,00
MR-28060024	MB-28060024	AB2251	AB2252	60	2,40
MR-28060030	MB-28060030	AB2260	AB2270	60	3,00
MR-28060040	MB-28060040	AB2290	AB2300	60	4,00
MR-28070030		AB2310		70	3,00
	MB-28085020		AB2324	85	2,00
MR-28085030	MB-28085030	AB2325	AB2326	85	3,00
MR-28130020	MB-28130020	AB2330	AB2340	130	2,00
MR-28130026	MB-28130026	AB2344	AB2345	130	2,60
MR-28160030	MB-28160030	AB2350	AB2360	160	3,00
MR-28230020	MB-28230020	AB2365	AB2366	230	2,00
MR-28240030	MB-28240030	AB2370	AB2380	240	3,00
MR-28240040	MB-28240040	AB2383	AB2384	240	4,00
MR-28230050	MB-28230050	AB2385	AB2386	230	5,00

LAMPES TUBES 10X28mm longue durée

MR-28006021LL	MB-28006021LL	AB1491	AB1492	6	2,10
MR-28012012LL		AB1702		12	1,20
MR-28012030LL	MB-28012030LL	AB1752	AB1762	12	3,00
	MB-28018030LL		AB1814	18	3,00
MR-28024006LL	MB-28024006LL	AB1815	AB1816	24	0,60
MR-28024020LL	MB-28024020LL	AB1832	AB1841	24	2,00

LAMPES TUBES 10X28mm longue durée

CODE SOGERI	CODE SOGERI	CODE ABI	CODE ABI	Volt	Watts
E10	BA9S	E10	BA9S		
MR-28026020LL		AB1892		26	2,00
	MB-28048020LL		AB2111	48	2,00
	MB-28060020LL		AB2249	60	2,00
MR-28060030LL		AB2261		60	3,00
MR-28070030LL		AB2312		70	3,00
	MB-28130018LL		AB2338	130	1,80
MR-28130015LL	MB-28130015LL	AB2341	AB2342	130	2,00
	MB-28130026LL		AB2346	130	2,60



LAMPES TUBES 10X35mm

CODE SOGERI	CODE SOGERI	CODE ABI	CODE ABI	Volt	Watts
E10	BA9S	E10	BA9S		
MR-35024020	MB-35024020	AB2390	AB2391	24	2,00
MR-35030030	MB-35030030	AB2430	AB2431	30	3,00
MR-35048030	MB-35048030	AB2480	AB2481	48	3,00
MR-35060030	MB-35060030	AB2510	AB2511	60	3,00
MR-35070030		AB2540		70	3,00
	MB-35085040		AB2551	85	4,00
MR-35130030	MB-35130030	AB2570	AB2571	130	3,00
MR-35150030	MB-35150030	AB2620	AB2621	150	3,00

LAMPES TUBES 10X50mm

MR-50024030	MB-50024030	AB2910	AB2911	24-30	3,00
MR-50048030		AB2940		48	3,00
MR-50060030		AB3000		60	3,00
MR-50130030		AB3050		130	3,00
MR-50160030	MB-50160030	AB3140	AB3141	160	3,00
MR-50230050		AB3170		230	5,00

LAMPES TUBES 13X30

E14	B15d	E14	B15d	Volt	Watts
MR-30006012	MB-30006012	AB3280	AB3290	6	1,20
MR-30006030	MB-30006030	AB3300	AB3310	6	3,00
MR-30012012	MB-30012012	AB3340	AB3350	12	1,20
MR-30012030	MB-30012030	AB3380	AB3390	12	3,00
MR-30024020	MB-30024020	AB3410	AB3420	24	2,00
MR-30024030	MB-30024030	AB3440	AB3450	24	3,00
MR-30030030	MB-30030030	AB3480	AB3490	30	3,00
MR-30018020		AB3560		48	2,00
MR-30048030	MB-30048030	AB3610	AB3620	48	3,00
MR-30060012	MB-30060012	AB3630	AB3640	60	1,20
MR-30060030	MB-30060030	AB3670	AB3680	60	3,00
MR-30130030	MB-30130030	AB3720	AB3725	130	3-4
MR-30240050		AB3731		240	5,00
MR-30240120	MB-30240120	AB3740	AB3745	240	3-4

LAMPES TUBES 16X35mm

E10	E12	E10	E12	Volt	Watts
MR-35012051		AB4034		12	5,00
MR-35024051		AB4078		24	5,00
MR-35036018		AB4139		36	1,80
MR-35048051		AB4219		48	5,00
MR-35130051		AB4360	AB4365	130	5,00



LAMPES TUBES 16X35mm

CODE SOGERI	CODE SOGERI	CODE ABI	CODE ABI	Volt	Watts
E10	E12	E10	E12		
MR-35260050		AB4510		260	5,00
MR-35260070		AB4568		220-260	5-7
MR-35260100		AB4585		260	10,00
E14	B15d	E14	B15d		
MR-35004050	MB-35004050	AB3970	AB3975	4,8	5,00
MR-35006040	MB-35006040	AB3980	AB3990	6	4,00
MR-35006050	MB-35006050	AB3995	AB3996	6	5,00
MR-35012025	MB-35012025	AB4000	AB4010	12	2,50
MR-35012040	MB-35012040	AB4020	AB4030	12	4,00
MR-35012050	MB-35012050	AB4035	AB4036	12	5,00
MR-35024030	MB-35024030	AB4060	AB4070	24	3,00
MR-35024050	MB-35024050	AB4080	AB4090	24	5,00
	MB-35028050		AB4097	28	5,00
MR-35030040	MB-35030040	AB4100	AB4110	30	4,00
MR-35030050	MB-35030050	AB4120	AB4130	30	5,00
MR-35048030	MB-35048030		AB4170	48	3,00
MR-35048040	MB-35048040	AB4200	AB4210	48	4,00
MR-35048050	MB-35048050	AB4220	AB4221	48	5,00
MR-35060030	MB-35060030	AB4229	AB4230	60	3,00
MR-35060040	MB-35060040	AB4240	AB4250	60	4,00
MR-35060050	MB-35060050	AB4263	AB4264	60	5,00
MR-35070040	MB-35070040	AB4270	AB4280	70	4,00
	MB-35085060		AB4320	85	6,00
MR-35130050	MB-35130050	AB4370	AB4380	130	5,00
MR-35140050	MB-35140050	AB4410	AB4420	140	5,00
MR-35140070	MB-35140070	AB4429	AB4430	140	7,00
MR-35160050	MB-35160050	AB4470	AB4480	160	5,00
MR-35220040	MB-35220040	AB4508	AB4509	220	4,00
MR-35260050	MB-35260050	AB4520	AB4530	260	5,00
MR-35260070	MB-35260070	AB4570	AB4580	220-260	5-7
MR-35260100	MB-35260100	AB4589	AB4590	260	10,00

LAMPES TUBES 16X44mm

E10	E12	E10	E12	Volt	Watts
MR-44024050		AB4645	AB4650	24	5,00
			AB4660	24	6,00
MR-44024060		AB4670		24	15,00
MR-44030051		AB4680		24-30	5,00
MR-44027050		AB4715		27	5,00
			AB4710	30	6,00
MR-44048051		AB4735		48	5,00
			AB4730	48	6,00
			AB4770	60	6,00
			AB4799	130	4,00
			AB4800	130-140	7,00
MR-44130100		AB4830		130	10,00
MR-44230100		AB4850		230	10,00
MR-44260050		AB4860	AB4865	220-260	5-7
			AB4890	250	10,00
MR-44250151		AB4893		250	15,00

LAMPES TUBES 16X44mm

CODE SOGERI	CODE SOGERI	CODE ABI	CODE ABI	Volt	Watts
E14	B15d	E14	B15d		
MR-44024030		AB4622		24	3,00
MR-44024050	MB-44024050		AB4655	24	5,00
MR-44030050	MB-440230050	AB4690	AB4700	24-30	5,00
MR-44048050	MB-44048050	AB4740	AB4750	48	5,00
MR-44060050	MB-44060050	AB4766	AB4767	60	5,00
MR-44060070	MB-44060070	AB4780	AB4790	60	7,00
	MB-44080060		AB4795	80	6,00
MR-44130070	MB-44130070	AB4810	AB4820	130-140	7,00
	MB-44220040	AB4832		220	4,00
MR-44260051	MB-44260050	AB4870	AB4880	220-260	5-7
MR44250150	MB-44250150	AB4896	AB4897	250	15,00

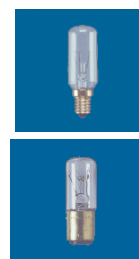

LAMPES SPHERIQUES 11X23mm

CODE SOGERI	CODE SOGERI	CODE ABI	CODE ABI	Volt	Watts
E10	BA9S	E10	BA9S		
MR-24001001		AC1140		1,5	0,10
MR-24001003		AC1161		1,5	0,30
MR-24002004		AC1201		2,2	0,40
MR-24002002		AC1210		2,5	0,20
MR-24002003		AC1220		2,5	0,25
MR-24002005		AC1240		2,5	0,50
		AC1251 dépolie		2,5	0,50
MR-24002008		AC1290		2,5	0,80
MR-24002125		AC1300		2,5	1,25
MR-24003040		AC1351		3,5	0,40
MR-24003007		AC1390		3,5	0,70
		AC1400 dépolie		3,5	0,70
MR-24003010		AC1431		3,5	1,00
MR-24004011		AC1432		3,8	1,14
MR-24004002		AC1441		4	0,20
MR-24004012		AC1446		4	1,20
MR-24004020		AC1451		4	2,00
	MB-24005002		AC1453	4,8	0,20
MR-24005010		AC1455		4,8	1,00
MR-24005024		AC1457		4,8	2,40
MR-24006002		AC1459		6	0,20
	MB-24006030		AC1461	6	0,30
MR-24006004		AC1462		6	0,40
MR-24006006	MB-24006006	AC1470	AC1480	6	0,60
MR-24006015	MB-24006015	AC1500	AC1510	6	1,50
MR-24006021		AC1530		6	2,00
	MB-24006030		AC1532	6	3,00
MR-24006036		AC1534		6	3,60
MR-24006007	MB-24006007	AC1150	AC1160	6,5	0,70
MR-24006010		AC1154		6,5	1,00
MR-24006020		AC1158		6,5	2,00
MR-24007007		AC1200		7	0,70
MR-24007020	MB-24007020	AC1250	AC1260	7	2,00
MR-24012005		AC1601		12	0,50
MR-24012006	MB-24012006	AC1625	AC1626	12	0,60
MR-24012012	MB-24012012	AC1350	AC1360	12	1,20

LAMPES SPHERIQUES 11X23mm

CODE SOGERI	CODE SOGERI	CODE ABI	CODE ABI	Volt	Watts
E10	BA9S	E10	BA9S		
MR-24012015	MB-24012015	AC1362	AC1363	12	1,50
MR-24012022	MB-24012022	AC1367	AC1368	12	2,20
MR-24012030	MB-24012030	AC1621	AC1630	12	3,00
MR-24019008		AC1410		19	0,80
MR-24020020		AC1420		20	2,00
MR-24024012	MB-24024012	AC1430	AC1440	24	1,20
MR-24024024	MB-24024024	AC1450	AC1460	24	2,40
MR-24024040	MB-24024040	AC1751	AC1810	24	4,00
MR-24024048		AC1490		24	4,80



LAMPES SPHERIQUES 15X28mm

CODE SOGERI	CODE SOGERI	CODE ABI	CODE ABI	Volt	Watts
E10	BA9S	E10	BA9S		
MR-29002010		AC1900		2,2	1,00
MR-29002012		AC1705		2,5	1,25
MR-29004020		AC1910		4	2,00
MR-29004015		AC1921		4,5	1,50
MR-29006006		AC1590		6	0,60
	MB-29006012		AC1595	6	1,20
MR-29006012		AC1596		6	1,80
MR-29006020		AC1600		6	2,00
MR-29006024		AC1610		6	2,40
MR-29006030	MB-29006030	AC1640	AC1650	6	3,00
	MB-29006050		AC1652	6	5,00
MR-29006060		AC2100		6	6,00
MR-29007017		AC2140		7	1,70
MR-29012020		AC1715		12	2,00
MR-29012030		AC1710		12	3,00
MR-29012040	MB-29012040	AC1720	AC1730	12	4,00
MR-29012050		AC1740		12	5,00
MR-29012060	MB-29012060	AC1750	AC1760	12	6,00
MR-29012100		AC1770		12	10,00
MR-29016030		AC1780		16	3,00
MR-29024030		AC1920	AC1922	24	3,00
MR-29024036		AC1924		24	3,60
MR-29024048		AC1930	AC1940	24	4,80
MR-29028042		AC1946		28	4,20
MR-29030030		AC1950		30	3,00
MR-29048030	MB-29048030	AC1980	AC1990	48	3,00
	MB-29048048		AC2030	48	4,80

Lampes à atmosphère ARGON

MR-29002025AG		AC2200AG		2,5	2,50
MR-29004040AG		AC2230AG		4	4,00
MR-29006060AG	MB-29006060AG	AC2250AG	AC2260AG	6	6,00

LAMPES SPHERIQUES 17X32mm Xénon

MR-32002024X		AC3040XE		2,4	2,40
MR-32002030X	MB-32002030X	AC3050XE	AC3051XE	2,4	3,00
MR-32003090X	MB-32004090X	AC3057XE	AC3058XE	3,6	0,90
MR-32004016X		AC3060XE		3,6	1,60
MR-32004036X	MB-32004036X	AC3070XE	AC3071XE	3,6	3,60
MR-32004034X		AC3080XE		3,75	3,40
MR-32004056X		AC3083XE		3,75	5,60

LAMPES SPHERIQUES 17X32mm Xénon

CODE SOGERI	CODE SOGERI	CODE ABI	CODE ABI	Volt	Watts
E10	BA9S	E10	BA9S		
MR-32004022X		AC3090XE		4	2,20
MR-32004032X		AC3100XE		4	3,20
MR-32006027X	MB-32006027X	AC3106XE	AX3107XE	6	2,70
MR-32006054X		AC3110XE		6	5,40
MR-32006060X		AC3120XE		6	6,00



LAMPES SPHERIQUES 18X35mm

E14	B15d	E14	B15d	Volt	Watts
	MB-36003017		AC2390	3,5	1,75
MR-36006030	MB-36006030	AC2400	AC2410	6	3,00
	MB-36006050		AC2415	6	5,00
	MB-36006100		AC2420	6	10,00
MR-36012030	MB-36012030	AC2550	AC2560	12	3,00
MR-36012050	MB-36012050	AC2561	AC2562	12	5,00
MR-36012100	MB-36012100	AC2564	AC2565	12	10,00
MR-36024030	MB-36024030	AC2650	AC2660	24	3,00
MR-36024050	MB-36024050	AC2662	AC2663	24	5,00
MR-36024100	MB-36024100	AC2664	AC2665	24	10,00
MR-36030030	MB-36030030	AC2700	AC2710	30	3,00
	MB-36030030		AC2810	48	3,00
	MB-36060050		AC2900	60	5,00
E10		E10			
MR-36012070		AC3140		12	7,00
MR-36030040		AC3160		30	4,00
MR-36048050		AC3180		48	5,00

Lampes à atmosphère ARGON

MR-36002030AG	AC2950AG		2,4	3,00
MR-36003034AG	AC2970AG		3,75	3,40
MR-36004032AG	AC3000AG		4	3,20
MR-36006060AG	AC3020AG		6	6,00

LAMPES ECLAIRAGE PORTATIF**Halogène 9,3X31**

CODE SOGERI	CODE ABI	Dimensions	Culot	Volt	Ma
MP-31003007	AJ213	9,3X31	P13,5S	2,8	850
MP-31004020	AJ214	9,3X31	P13,5S	4	500
MP-31004034	AJ215	9,3X31	P13,5S	4	850
MP-31004040	AJ216	9,3X31	P13,5S	4	1A
MP-31005026	AJ218	9,3X31	P13,5S	5,2	500
MP-31005044	AJ219	9,3X31	P13,5S	5,2	850
MP-31006024	AJ220	9,3X31	P13,5S	6	400
MP-31006045	AJ221	9,3X31	P13,5S	6,5	700
MR-31003024	AJ222	9,3X31	E10	2,8	850
MR-31004020	AJ223	9,3X31	E10	4	500
MR-31004034	AJ224	9,3X31	E10	4	850
MR-31005044	AJ227	9,3X31	E10	5,2	850
MB-31012050	AJ630	9,3X31	BA9s	12	416
MB-31012100	AJ632	9,3X31	BA9s	12	866
MB-21012200	AJ634	9,3X31	BA9s	12	1,6A

Préfocus 11,5X30,5

CODE SOGERI	CODE ABI	Dimensions	Culot	Volt	Ma
sous vide					
MP-30023006	AC2300	11,5X30,5	P13,5s	2,3	270
MP-30024012	AC2301	11,5X30,5	P13,5s	2,4	500
MP-30025005	AC2305	11,5X30,5	P13,5s	2,5	200
MP-30025007	AC2306	11,5X30,5	P13,5s	2,5	300
MP-30025012	AC2307	11,5X30,5	P13,5s	2,5	500
MP-30036018	AC2310	11,5X30,5	P13,5s	3,6	500
MP-30004011	AC2312	11,5X30,5	P13,5s	3,8	300
MP-30047023	AC2314	11,5X30,5	P13,5s	4,7	500
MP-30072039	AC2318	11,5X30,5	P13,5s	7,2	550

au krypton

MP-30022011K	AC2350	11,5X30,5	P13,5s	2,2	500
MP-30002017K	AC2354	11,5X30,5	P13,5s	2,4	700
MP-30003028K	AC2358	11,5X30,5	P13,5s	3,6	750
MP-30005036K	AC2362	11,5X30,5	P13,5s	4,8	750
MP-30006045K	AC2364	11,5X30,5	P13,5s	6	750
MP-30072039K	AC2366	11,5X30,5	P13,5s	7,2	550

Tube super loupe

	AB6960	10X28	E10	2,5	300
	AB6967	10X28	E10	3,7	500

